



State of Kuwait
Ministry of Education



Modified
FUN WITH
English
Handwriting Book



 LONGMAN

Grade
3



State of Kuwait
Ministry of Education



Modified

FUN WITH

English

Handwriting Book



Grade

3

© **Ministry of Education - State of Kuwait. 2017**

All rights reserved; no part of this publication may be reproduced, stored in a retrieval system, or transmitted in any form or by any means, electronic, mechanical, photocopying, recording, or otherwise, without the prior written permission of the Publishers.

Egyptian International Publishing Company - Longman,
10a Hussein Wassef Street,
Messaha Square,
Dokki,
Cairo,
Arab Republic of Egypt

The Longman imprint is the property of Pearson Education being used under license from Pearson Education.

First edition 2004
Second edition 2006
Third edition 2009
Fourth edition 2017, 2019

Printed in Kuwait by:

Arwa Universal Printing Press



PDF Book

The Ministry of Education wishes to thank the Evaluation Committee of Kuwait Ministry of Education:

Professor Najat Al Mutawa, Kuwait University;
Professor M. Rifqy Eassa, Educational Holding Group;
Dr. Yusur Al-Madani, Kuwait University;
Dr. Badria A. Al-Haji, College of Basic Education (PAAET);
Mrs. Sakina A. Hussain, Senior Supervisor, MoE;
Mr. Mohamed Naguib Ali, ELT Supervisor, MoE;
Mr. Sayed Ghareeb Abdel Rahman, Supervisor, MoE;
Mr. Alhu Hamu Sharaha, Senior Teacher, MoE;
Mrs. Khawla Al Refae, Senior Teacher, MoE;
Ms. Aisha Al-Awadhi, Assistant Principal, MoE.

The Ministry of Education wishes to thank the Amendments Committee of Kuwait Ministry of Education:

Mrs. Nouria Al Sedra, ELT Senior Supervisor, MoE;
Mr. Mohamed Nagib Ali, ELT Supervisor, MoE;
Mr. Sayed Ghareeb AbdelRahman, ELT Supervisor, MoE;
Mr. Mahmoud Hammouda, ELT Supervisor, MoE;
Mrs. Khawla Al Refae, ELT Supervisor, MoE;
Mr. Mohamed Sallam, ELT Supervisor, MoE;
Mrs. Sherifah Al Sayegh, ELT Head of Department, MoE;
Mrs. Rehab Mohamed Nadim, ELT Head of Department, MoE;
Mrs. Rehab Mohamed Hasabullah, ELT Head of Department, MoE;
Mrs. Hessa Al-Banwan, ELT Head of Department, MoE;
Mrs. Noura Al-Mokmash Al-Azmi, ELT Head of Department, MoE;
Mrs. Azza Mohammad Awad, ELT Head of Department, MoE;
Mrs. Nevine Abdul Majeed Omar, ELT Head of Department, MoE.

The Ministry of Education wishes to thank the Amendments Committee of Kuwait Ministry of Education (2017):

Mrs. Hadeel Hassan Al Kandari, ELT Senior Supervisor, MOE;
Mrs. Abeer AL Jeeran, ELT Supervisor, MOE ;
Mrs. Germeen Gendia, ELT Supervisor, MOE;
Mrs. Rehab Mohamed Nadim, ELT Supervisor, MOE;
Ms. Sakeena Kankouni, ELT HOD, MOE;
Mrs. Mariam Mendakar, ELT HOD, MOE;
Ms. Joza M. Al-Otaibi, HOD, Curricula Development Departemnet



Share on evaluation



**H.H. Sheikh Sabah Al-Ahmad Al-Jaber Al-Sabah
The Amir of the State of Kuwait**



**H.H. Sheikh Nawwaf Al-Ahmad Al-Jaber Al-Sabah
The Crown Prince of the State of Kuwait**

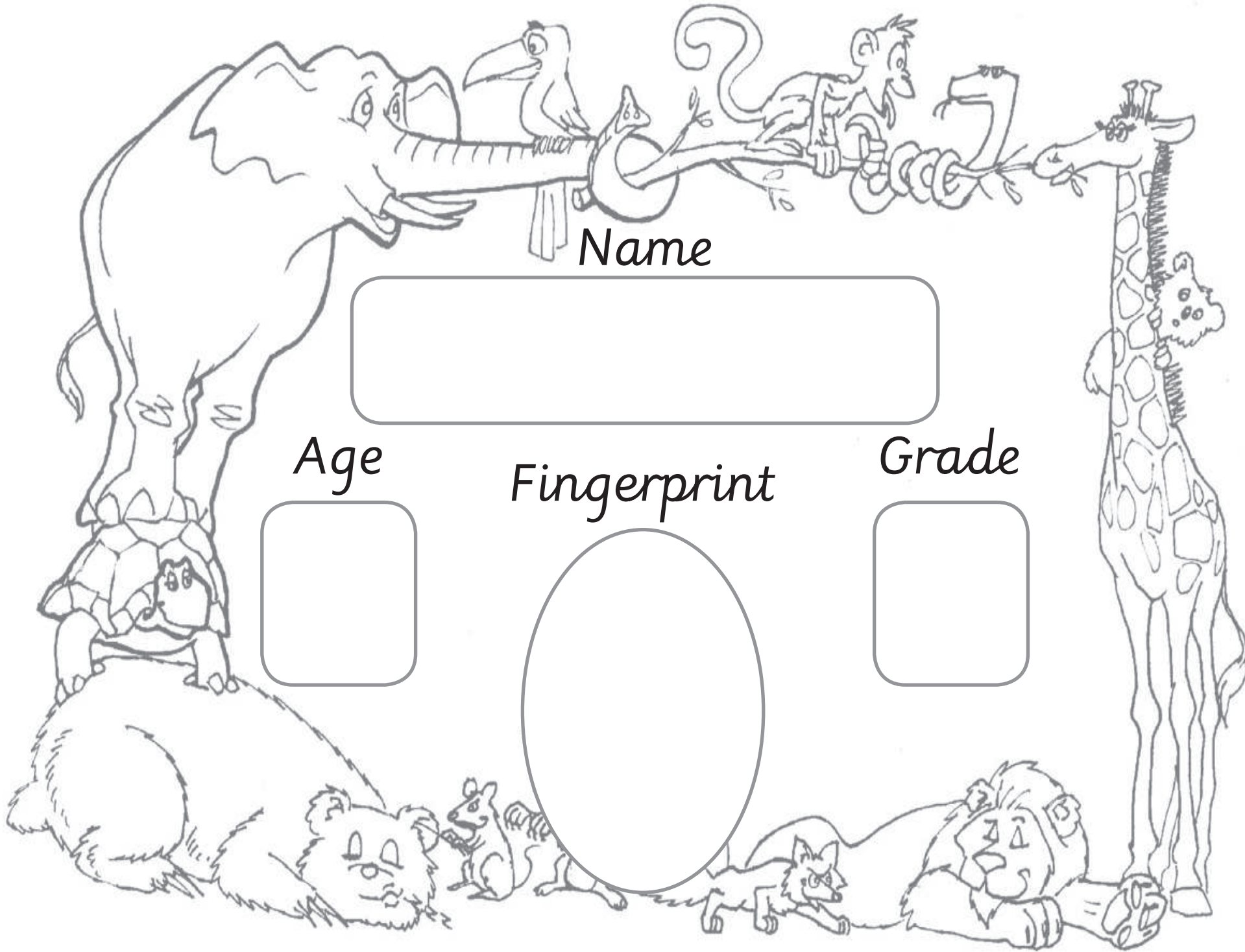

Name

Age

Fingerprint

Grade

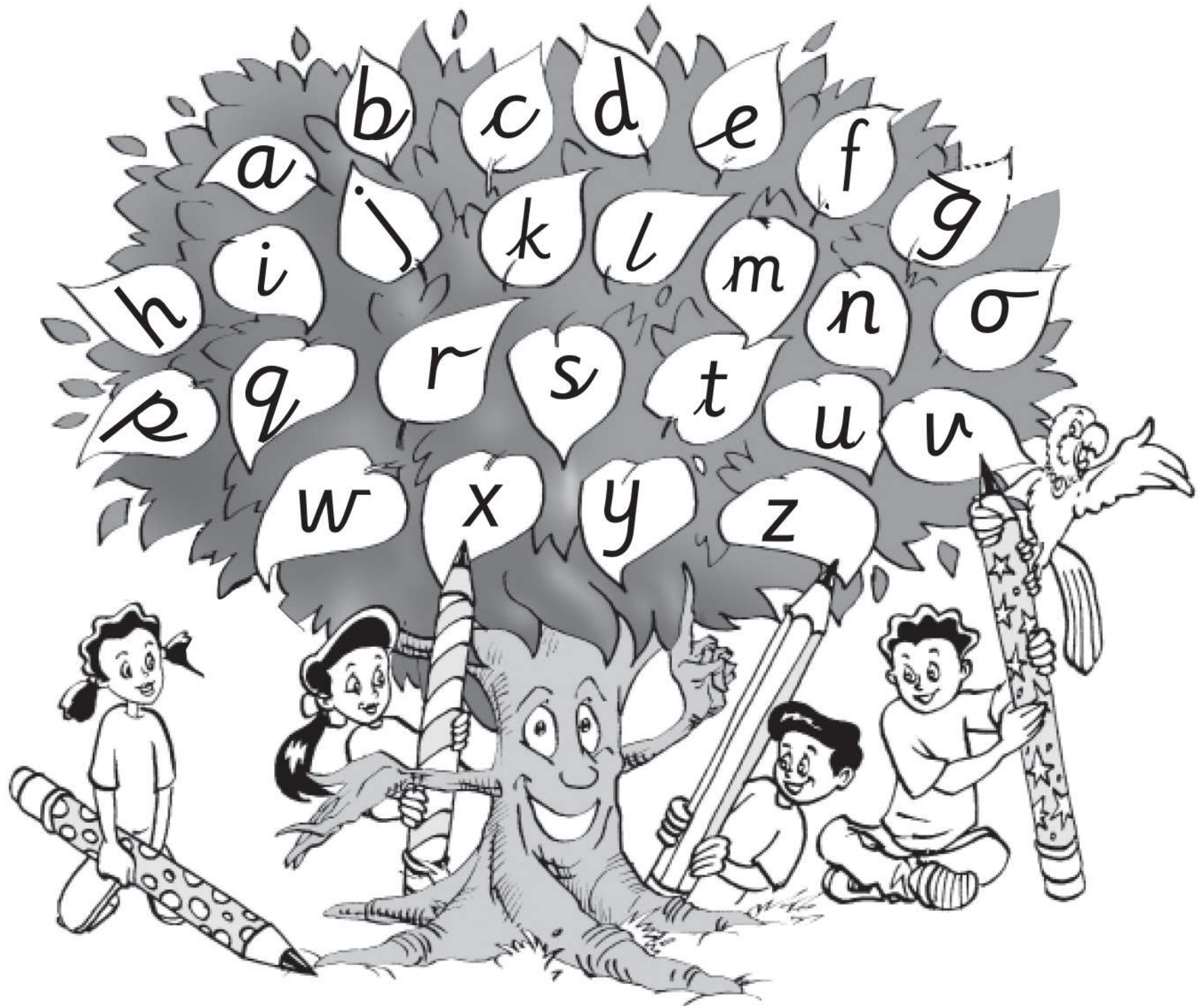

Trace and copy

a e m r u w

Blank handwriting practice line with a solid top and bottom line and a dashed middle line.

Blank handwriting practice line with a solid top and bottom line and a dashed middle line.



b d h k l

Blank handwriting practice line with a solid top and bottom line and a dashed middle line.

Blank handwriting practice line with a solid top and bottom line and a dashed middle line.



Trace and copy

p g q y

Blank handwriting practice line with a solid middle line and dotted top and bottom lines.

Blank handwriting practice line with a solid middle line and dotted top and bottom lines.

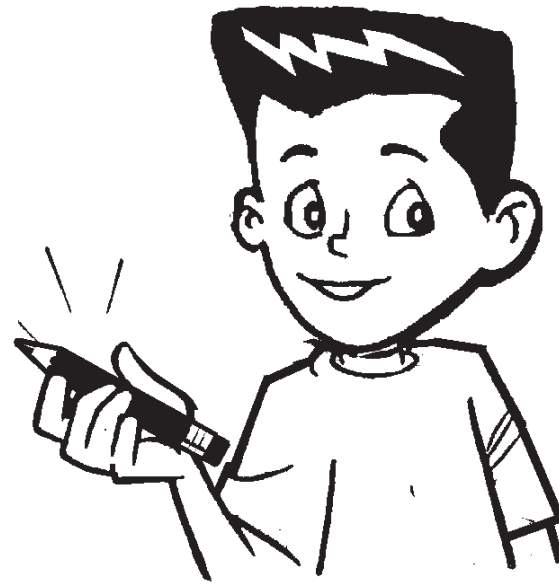

i j t f

Blank handwriting practice line with a solid middle line and dotted top and bottom lines.

Blank handwriting practice line with a solid middle line and dotted top and bottom lines.



Trace and copy

A B C D E F

Blank handwriting practice line with a solid top and bottom line and a dashed middle line.



G H I J K L M N O P

Blank handwriting practice line with a solid top and bottom line and a dashed middle line.

Q R S T U V W X Y Z

Blank handwriting practice line with a solid top and bottom line and a dashed middle line.



Trace and copy

mosque mosque mosque

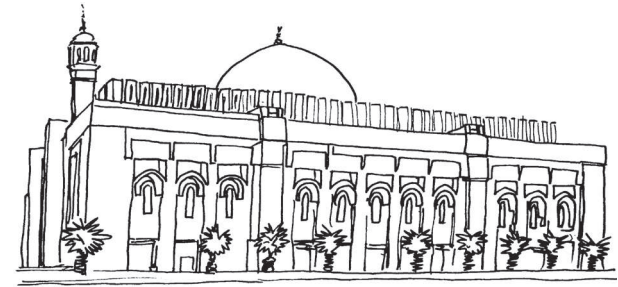

shops shops shops shops



tower tower tower tower



Trace and copy

photo photo photo

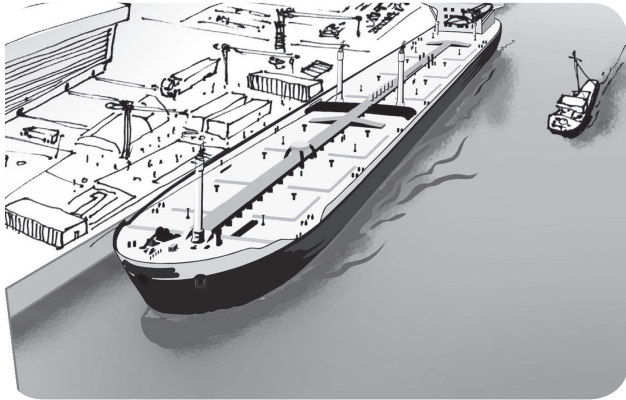
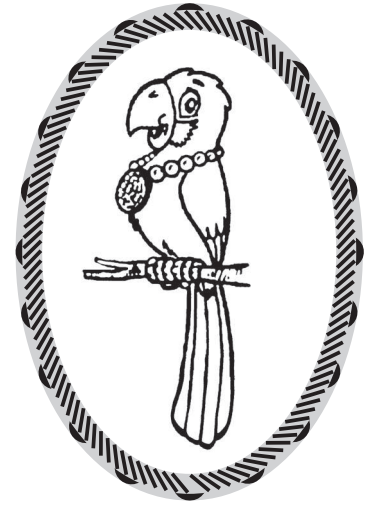

harbour harbour harbour

sea sea sea sea

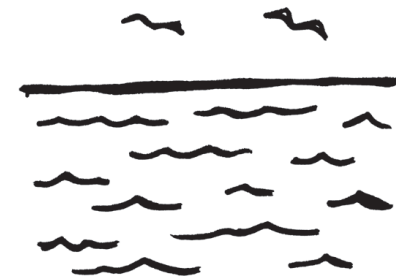

Trace and copy

email email email

Blank handwriting practice lines for the word 'email'.



parrot parrot parrot

Blank handwriting practice lines for the word 'parrot'.

beach beach beach

Blank handwriting practice lines for the word 'beach'.



Trace and copy

grandmother grandmother

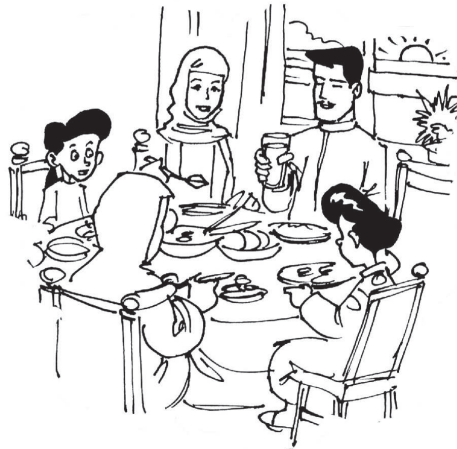

breakfast breakfast

get up get up get up



Trace and copy

sunrise sunrise sunrise

Blank handwriting practice lines for the word 'sunrise'.

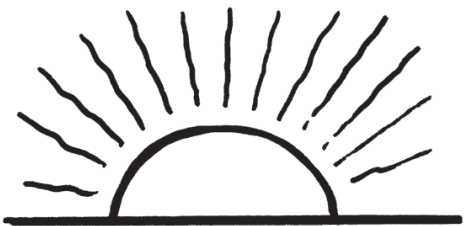
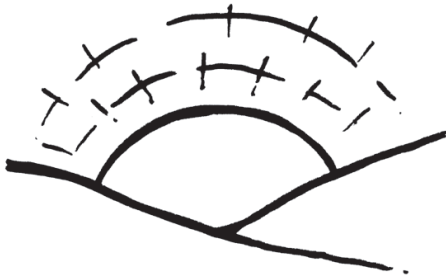

sunset sunset sunset

Blank handwriting practice lines for the word 'sunset'.

dinner dinner dinner

Blank handwriting practice lines for the word 'dinner'.

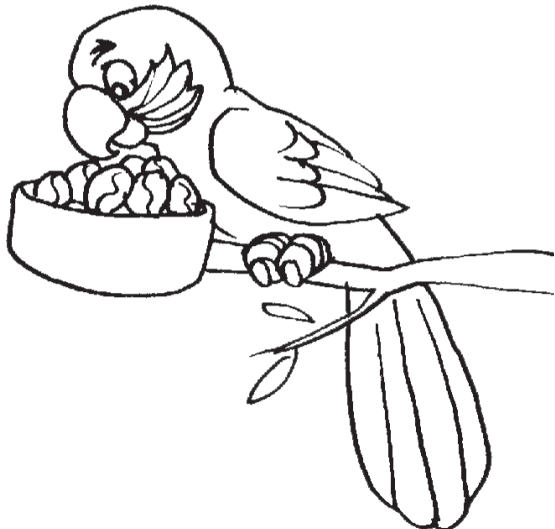

Trace and copy

zoo zoo zoo zoo

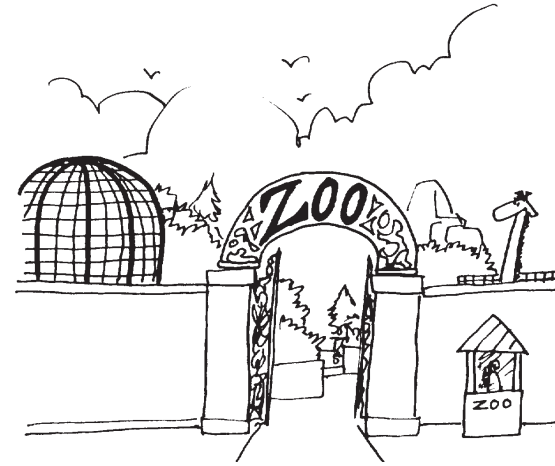

work work work

tomorrow tomorrow

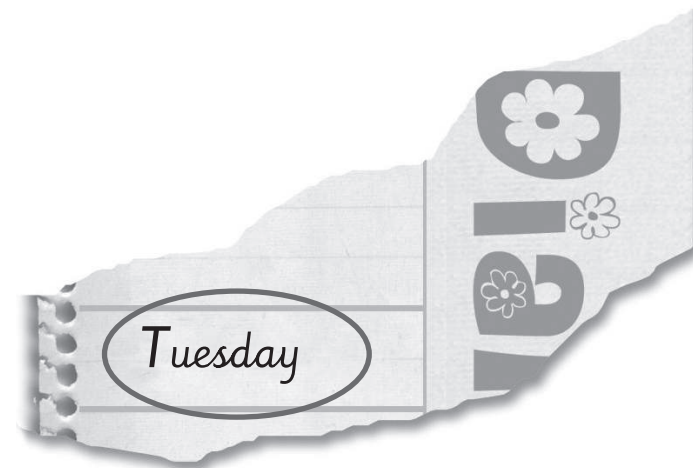

Trace and copy

I'm painting. *I'm painting.*

Blank dotted line for tracing practice.

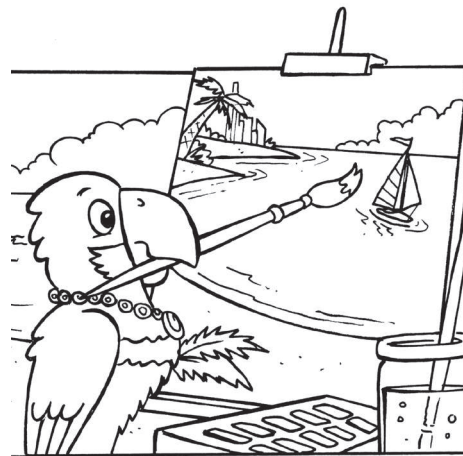

I collect stamps.

I collect stamps.

Blank dotted line for tracing practice.

Blank dotted line for tracing practice.



Trace and copy

I like collecting shells. *I like collecting shells.*



I like sailing. *I like sailing.*



Trace and copy

Salma has thirty dolls. Salma has thirty dolls.



My hobby is playing football.

My hobby is playing football.



Trace and copy

The firemen were brave. The firemen were brave.



There was a fire. There was a fire.



Trace and copy

A baker works in a bakery.

A baker works in a bakery.



I want to be a zookeeper.

I want to be a zookeeper.



Trace and copy

I want to be a doctor. *I want to be a doctor.*

Two sets of blank handwriting lines for tracing and copying the sentence "I want to be a doctor."



I want to be an artist. *I want to be an artist.*

Two sets of blank handwriting lines for tracing and copying the sentence "I want to be an artist."



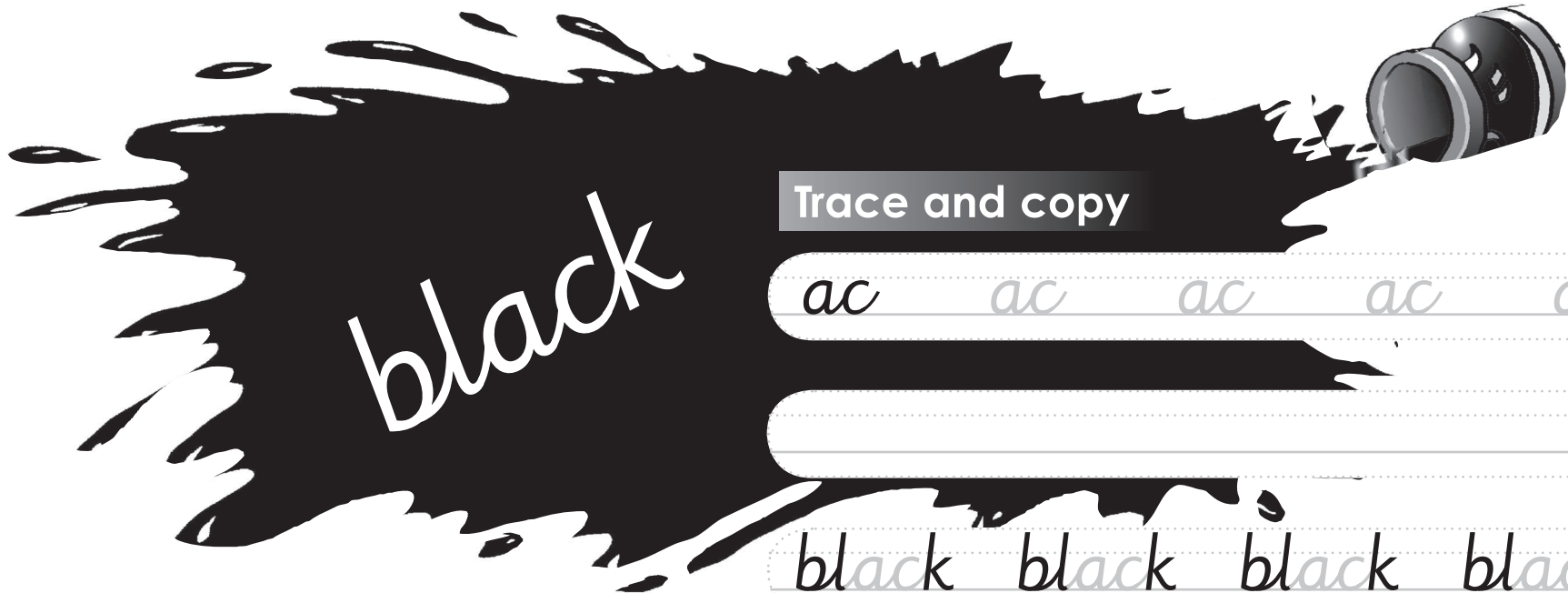

Trace and copy

ac ac ac ac ac

black black black black

ea ea ea ea ea

eat eat eat eat eat



Trace and copy

an an an an an

man man man man

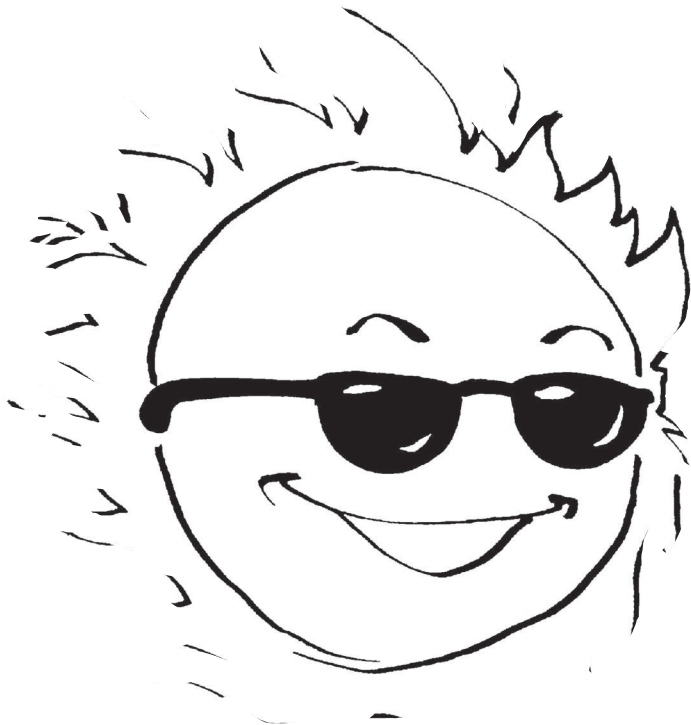

un un un un un

sun sun sun sun sun

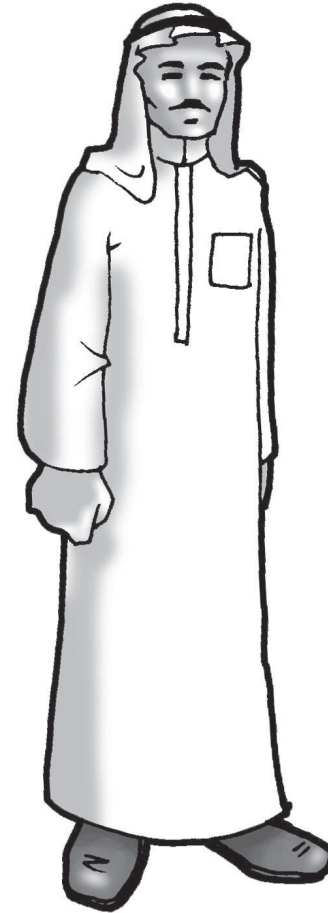

Trace and copy

um um um um um

mum mum mum mum

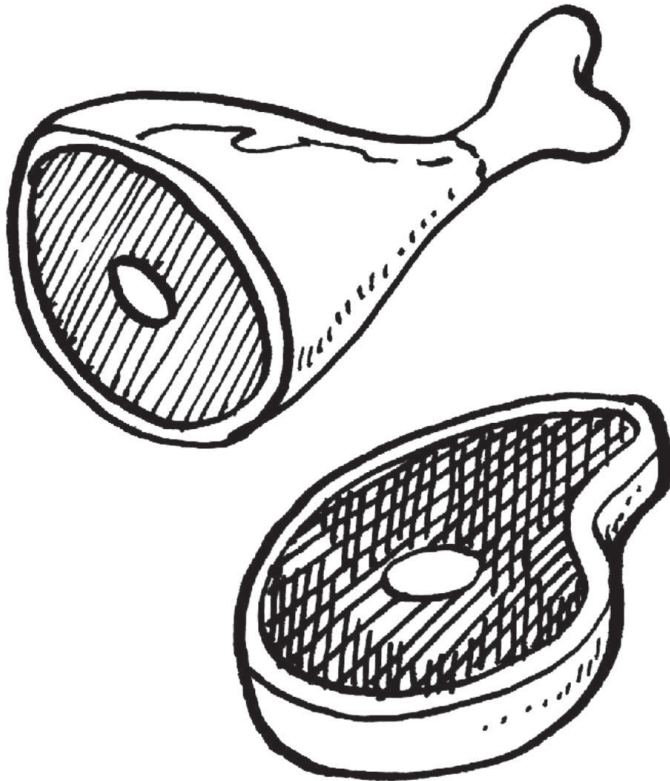
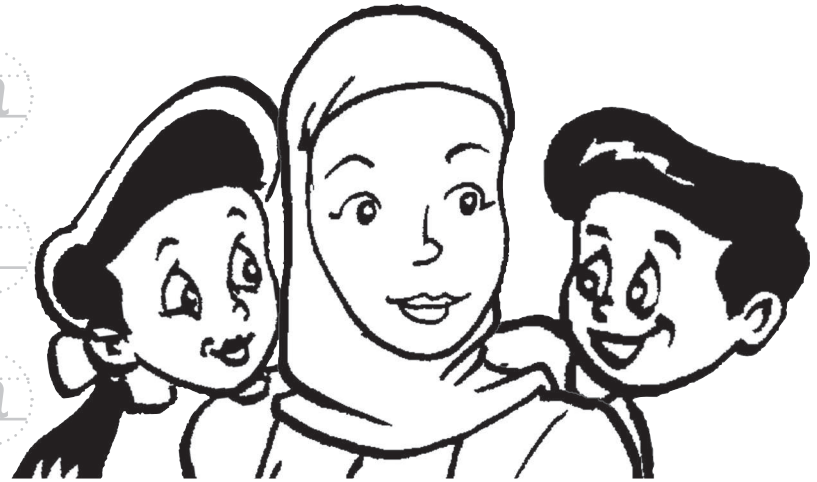

me me me me me

meat meat meat meat



Trace and copy

ou ou ou ou ou

mouth mouth mouth

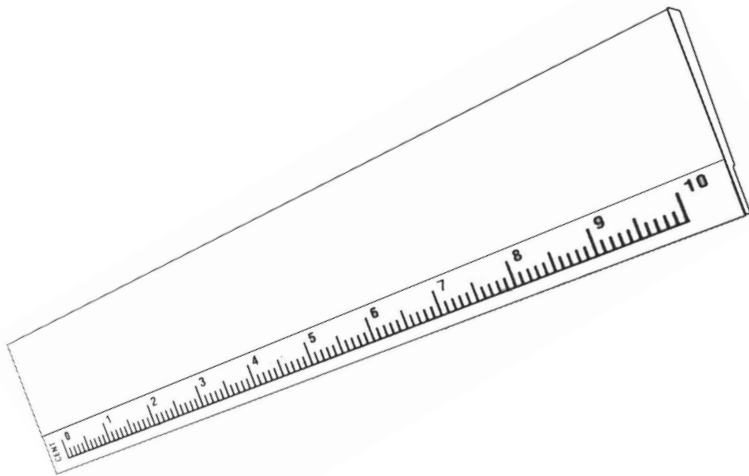

ru ru ru ru ru

ruler ruler ruler ruler



Trace and copy

re re re re re

dress dress dress dress

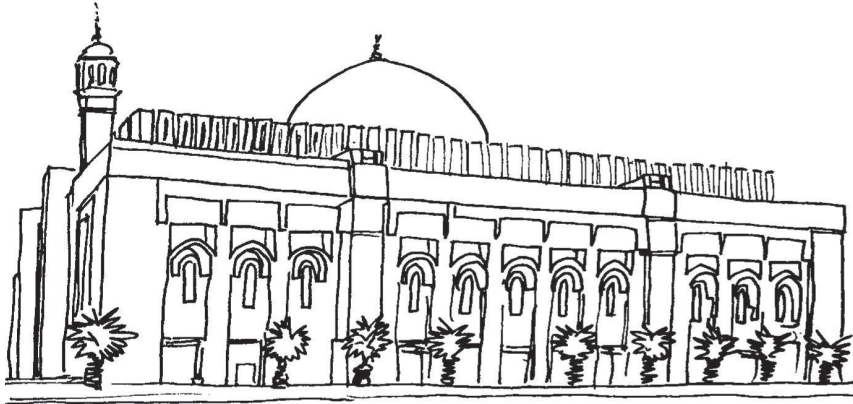

os os os os os

mosque mosque mosque

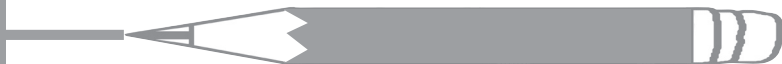

Trace and copy

wa wa wa wa wa

Kuwait Kuwait Kuwait

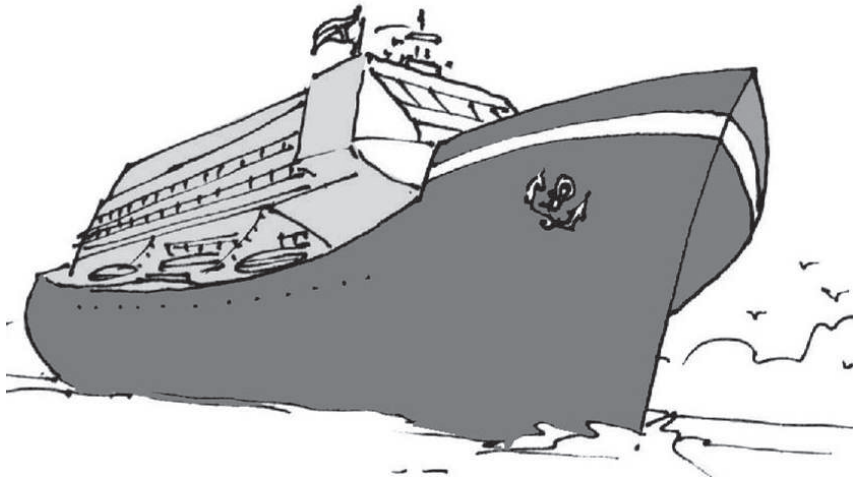
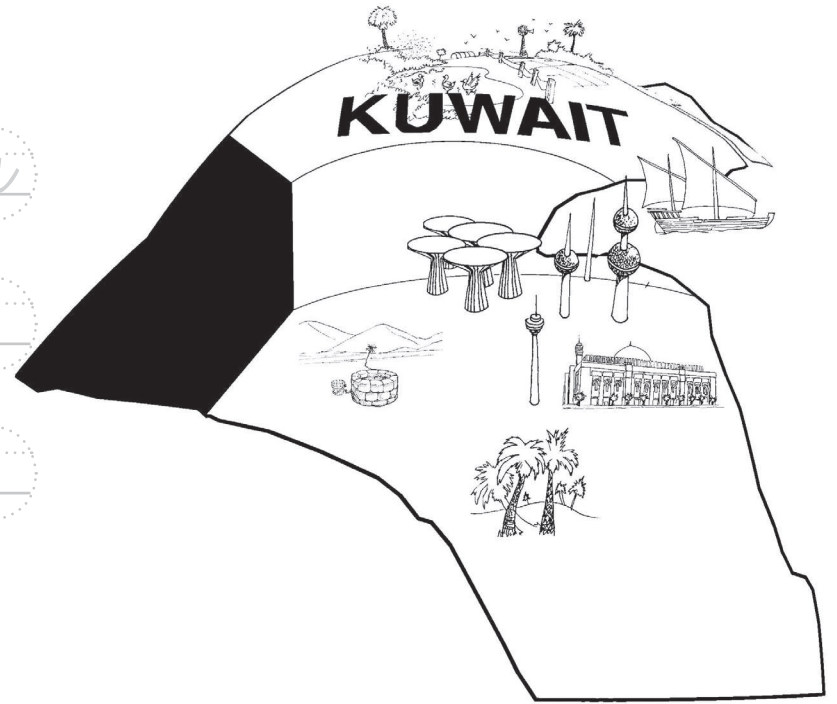

oa oa oa oa oa

boat boat boat boat



Trace and copy

ch ch ch ch ch

chair chair chair chair

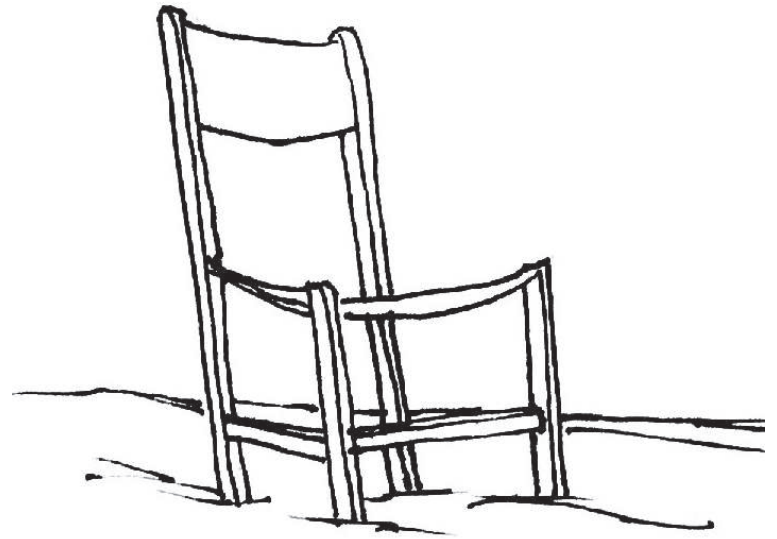

al al al al al

falcon falcon falcon



Trace and copy

ab ab ab ab ab

rabbit rabbit rabbit

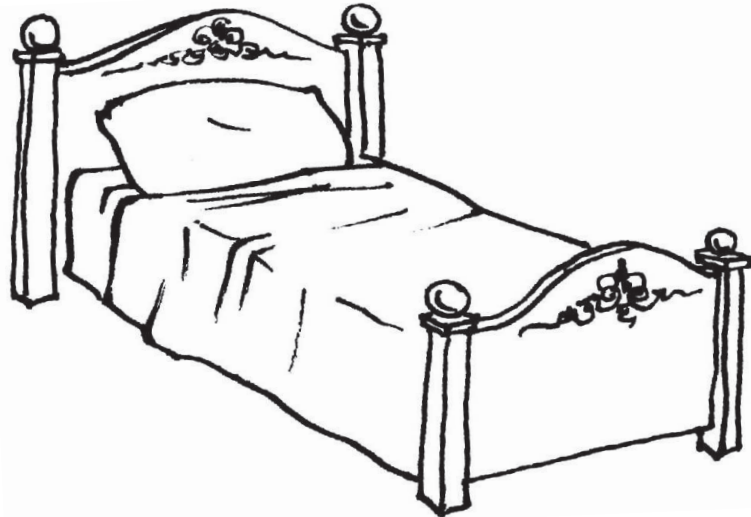
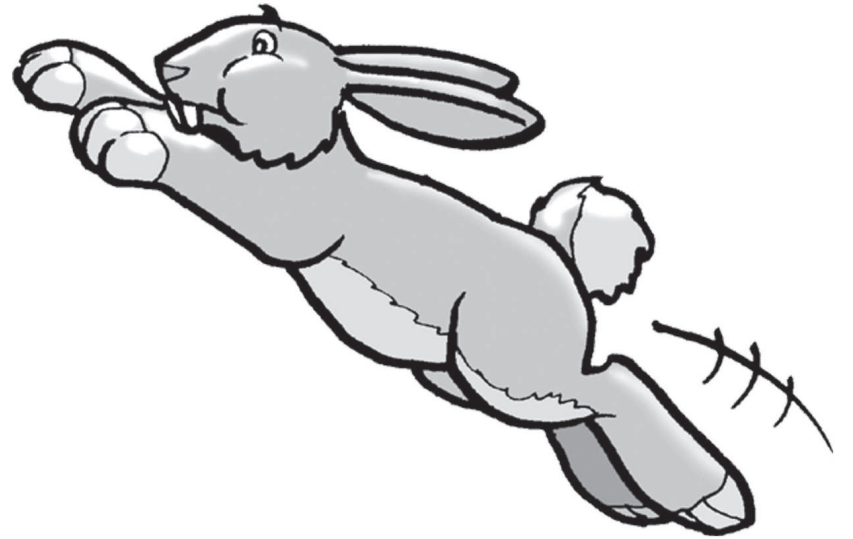

ed ed ed ed ed

bed bed bed bed bed



Trace and copy

he he he he he

Blank handwriting practice line with a solid top line, a dashed middle line, and a solid bottom line.

hen hen hen hen hen

da da da da da

Blank handwriting practice line with a solid top line, a dashed middle line, and a solid bottom line.

dad dad dad dad



Trace and copy

lu lu lu lu lu

Blank handwriting practice line with a solid top line, a dashed middle line, and a solid bottom line.

lunch lunch lunch lunch



be be be be be

Blank handwriting practice line with a solid top line, a dashed middle line, and a solid bottom line.

beach beach beach beach



Trace and copy

la la la la la



class class class class

ke ke ke ke ke



bike bike bike bike bike

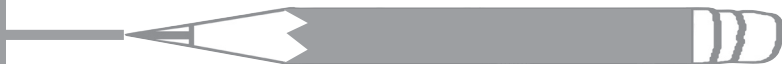

Trace and copy

rb rb rb rb rb

harbour harbour harbour

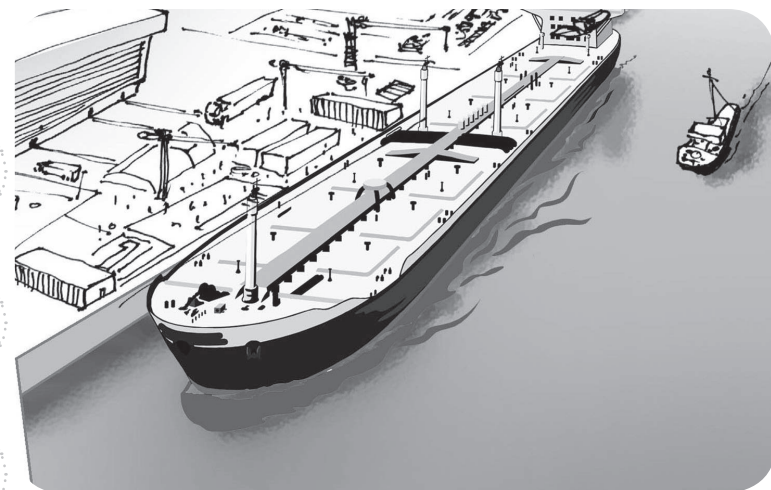

oll oll oll oll

doll doll doll doll



Trace and copy

ig ig ig ig ig

Blank handwriting practice lines for the word 'ig'.

big big big big big

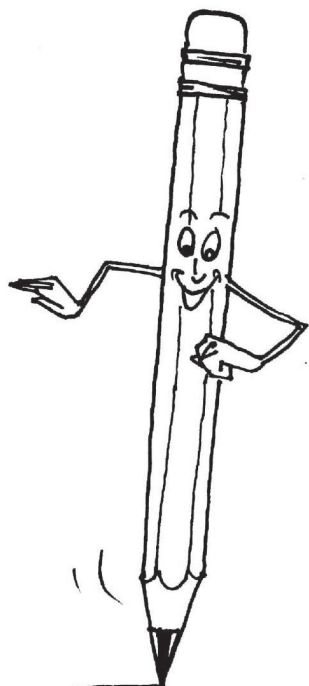
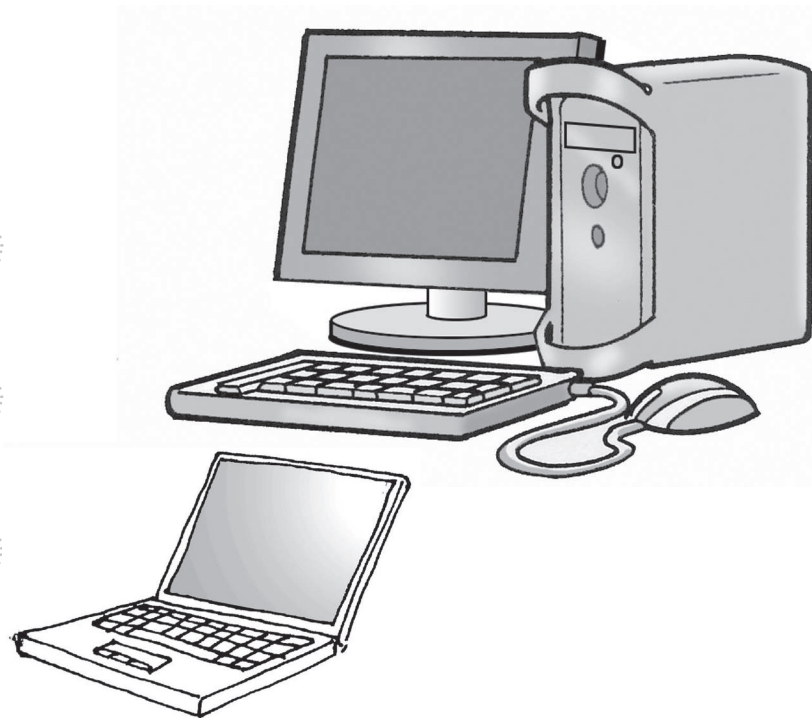

pe pe pe pe pe

Blank handwriting practice lines for the word 'pe'.

pencil pencil pencil pencil



Trace and copy

op op op op op

shop shop shop shop



ry ry ry ry ry

library library library



Trace and copy

fe fe fe fe fe

giraffe giraffe giraffe

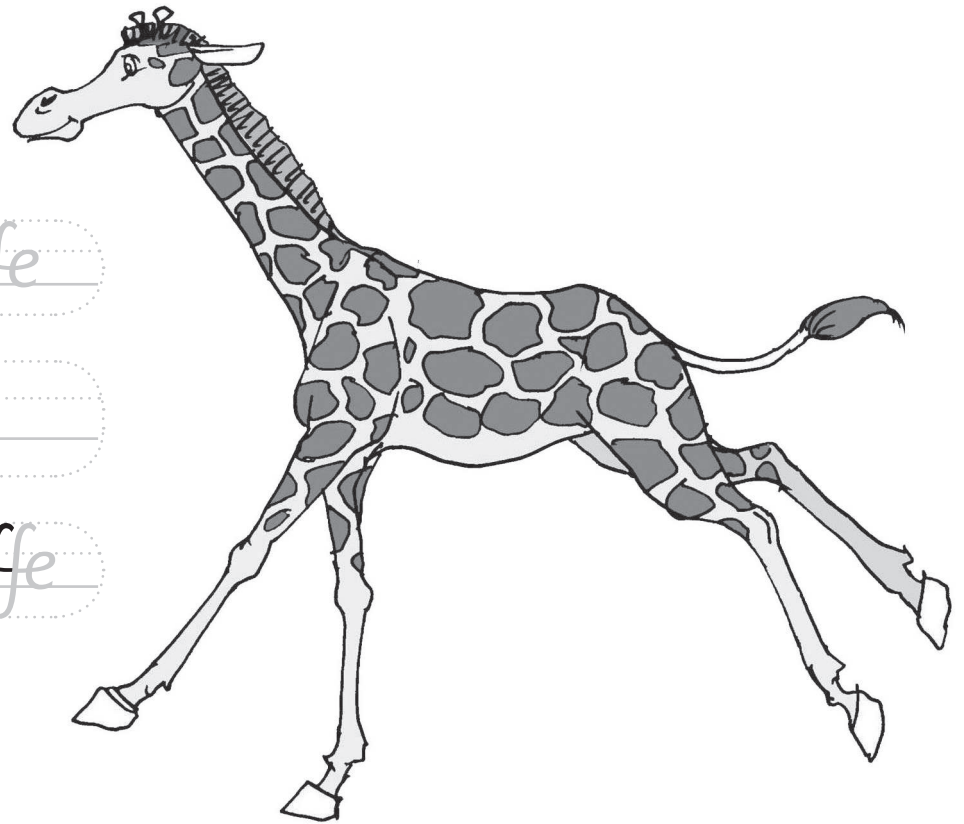

ts ts ts ts ts

biscuits biscuits biscuits

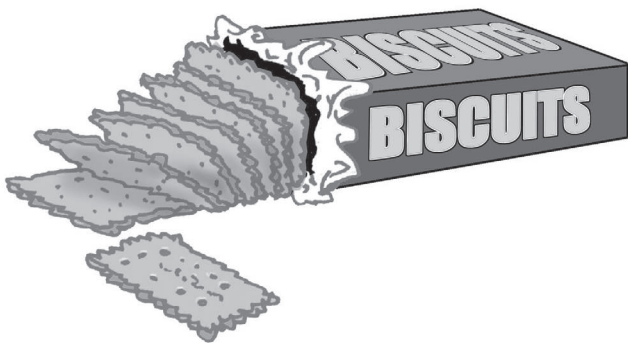

Trace and copy

desert desert desert

Blank handwriting practice lines for the word 'desert'.

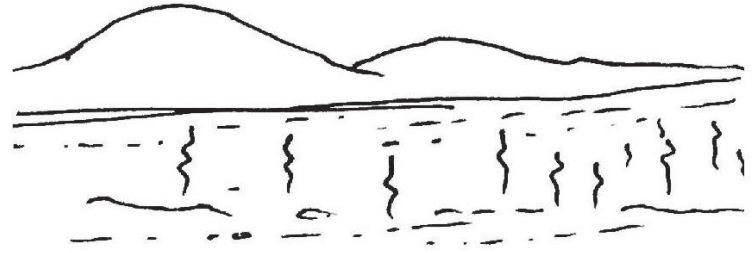
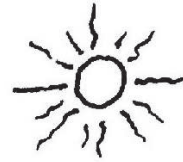

stars stars stars stars

Blank handwriting practice lines for the word 'stars'.

plants plants plants

Blank handwriting practice lines for the word 'plants'.



Trace and copy

sunny sunny sunny sunny

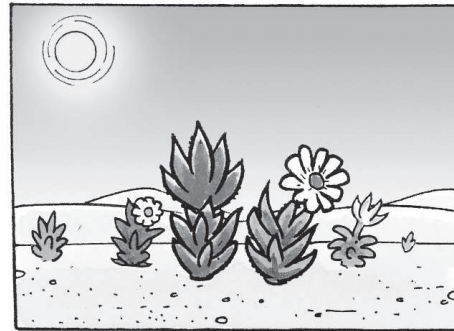

Blank handwriting lines for copying the word 'sunny'.



windy windy windy

Blank handwriting lines for copying the word 'windy'.

rainy rainy rainy

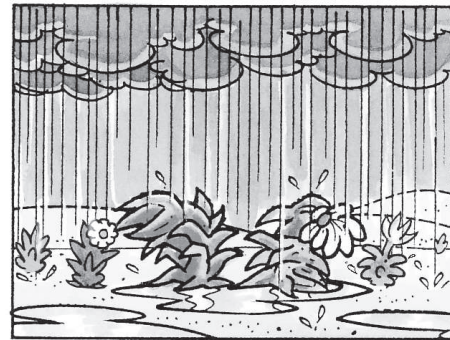

Blank handwriting lines for copying the word 'rainy'.



Trace and copy

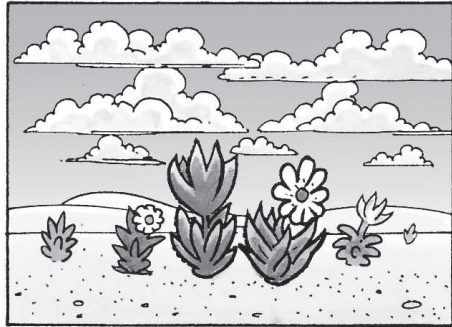

cloudy cloudy cloudy

weekend weekend weekend



night night night night



Trace and copy

doctor doctor doctor doctor



stomach stomach stomach

medicine medicine medicine

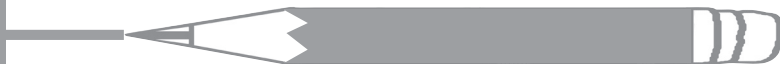

Trace and copy



vegetables vegetables vegetables

Blank handwriting practice lines consisting of a solid top line, a dashed middle line, and a solid bottom line.

fish fish fish fish

Blank handwriting practice lines consisting of a solid top line, a dashed middle line, and a solid bottom line.

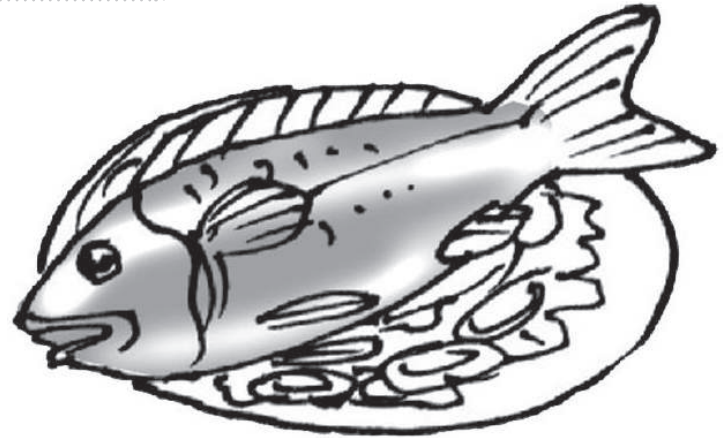

fruit fruit fruit fruit fruit

Blank handwriting practice lines consisting of a solid top line, a dashed middle line, and a solid bottom line.



Trace and copy



knife knife knife knife

Blank handwriting practice line with a solid top and bottom line and a dashed middle line.

spoon spoon spoon spoon

Blank handwriting practice line with a solid top and bottom line and a dashed middle line.

fork fork fork fork

Blank handwriting practice line with a solid top and bottom line and a dashed middle line.

