



State of Kuwait
Ministry of Education

Modified



Target English

Workbook



 **LONGMAN**

Judith Greet

Grade

6

تم تحميل الملف من

مدرستي

الكويتية

school-kw.com



للوصول الأسرع لحلول الكتب
همل التطبيق **اضغط هنا**

تجدنا في هوجل اكتب «مدرستي» 

© Ministry of Education - State of Kuwait. 2007
All rights reserved; no part of this publication
may be reproduced, stored in a retrieval system,
or transmitted in any form or by any means, elec-
tronic,
mechanical, photocopying, recording, or otherwise,
without the prior written permission of the
Publishers.

The Longman imprint is the property of Pearson
Education
being used under license from Pearson Education.

First printed in 2007 / 2008

2nd Edition 2016 / 2017
2017 / 2018 - 2019 / 2020

Deposit No. : 37 / 2016

Printed in Kuwait by: German Press Company for
Printing & Packaging

Acknowledgements:

The authors and publishers are grateful to all those who
have given permission to reproduce copyright material, in
particular the artist Ayoub Hussein

The publisher wishes to thank the Evaluation
Committee of Kuwait Ministry of Education:

Professor Najat Al-Mutawa, Kuwait University;
Professor M. Rifqy Eassa, Educational Holding
Group;
Dr. Yusur Al-Madani, Kuwait University;
Dr. Badria A. Al-Haji, College of Basic Education
(PAEET);
Mrs. Sakina A. Hussein, Senior Supervisor, MoE;
Mr. Mohamed Nagib Ali, ELT Supervisor, MoE;
Mr. Sayed Ghareeb Abdel Rahman, Supervisor,
MoE;
Mr. Alhu Hamu Sharaha, Senior Teacher, MoE;
Mrs. Khawla Al-Refae, Senior Teacher, MoE;
Ms. Aisha Al-Awadhi, Assistant Principal, MoE.

The publisher wished to thank the Modification
Committee of Kuwait Ministry of Education (2016/2017)

Mrs Suzan AL-Bashiti, ELT General Supervisor, MoE
Mrs Huda AL Ammar, ELT Senior Supervisor, MoE
Mr MY Abdelaziz Adnani, ELT Supervisor, MoE
Mr Ashraf ALi Khaled, ELT Supervisor, MoE
Mr El Habib Rezzouk, ELT Supervisor, MoE
Mrs Fatma Muhammad Al Kamali, Teacher, MoE
Mr Khaled Fahad Al Dhafeeri, Teacher, MoE
Ms Joza Al Otaibi, Head of Foreign Languages, MoE



PDF Book



Share on evaluation

بِسْمِ اللَّهِ الرَّحْمَنِ الرَّحِيمِ

Table of Contents

Snapshots of Kuwait

Module 1

Unit 1	A famous artist	11
Unit 2	An advertisement for Kuwait	16
Unit 3	A local television programme	21
Progress check	26

World of Water

Module 2

Unit 4	Potable water	29
Unit 5	Sea world secrets.....	34
Unit 6	A brave boy	39
Progress check	44

Science and Scientists

Module 3

Unit 7	Science Data	47
Unit 8	Science in our life	52
Unit 9	Famous people.....	57
Progress check	62

Countries and Holiday

Module 4

Unit 10	Communicating with the world	65
Unit 11	A beautiful country	70
Unit 12	On Holiday.....	75
Progress check	80

1. a: Complete the sentences with the words in the box.

manazz wood karouka cot
painting parents palm leaves

Look at the picture on page 17 of the Student's Book.

This is a (1) painting of a bedroom in an old Kuwaiti house. The (2) parents bed is on the floor. There is no (3) cot. The baby is sleeping in a basket next to the parents' bed. Soon the baby will sleep in a (4) karouka made of (5) wood or a (6) manazz.

1. b: What else can you see in the picture?

2. True (✓) or false (✗)?

✓ or ✗

1. Ayoub Hussein was born over seventy years ago.
2. He used to work in a school.
3. He paints pictures of modern Kuwait.
4. He built the Kuwait Museum.
5. He was thirty-four when he started working at the Kuwait Museum.

T

T

F

F

F



Correct the false sentences above and rewrite them.

Ayoub Hussein painted pictures of old Kuwait

He worked at Kuwait Museum

He was twenty four when he started working At Kuwait Museum

Unit 1

3. Finish the sentences with **used to** or **didn't use to**.

Huda has lived in Canada for two years. She is visiting her grandmother.

Grandmother: Would you like some milk to drink?

Huda: No, thank you. I (1) used to like milk, but I don't now. Can I have some tea, please?

Grandmother: You (2) didn't use to like tea – you never drank it. What would you like to eat? Some yoghurt?

Huda: No, thank you. I (3) used to like yoghurt, but I prefer cheese now. Are you going to play tennis this morning?

Grandmother: No, I don't play tennis any more. I (4) used to play three times a week, but now I go swimming.

Huda: Swimming? You (5) didn't use to like swimming.

Grandmother: You're right, but now I love it. We have changed!

4. Write questions and answer them. Then ask a friend.

what / drink / when you were a baby

What did you use to drink when you were a baby?



I used to drink a lot of milk

1. who/play with/when you were five.

Who did you use to play with when you were five

2. what school/go to/when you were nine

What school did you use to go to when you were nine

3. when/go to bed/when you were six

When did you use to go to bed when you were six

4. which book/like best/when you were younger

Which book did you use to like best when you were younger

5. Write the words, then finish the sentence.

1. If the sea is rough, it can be dangerous.
2. Tables and chairs are kinds of furniture.
3. The baby's manazz was made of these. palm leaves
4. A baby's bed. cot
5. We can see old Kuwait in more than 600 of Ayoub Hussein's paintings.
6. Ayoub Hussein used to be a teacher.
7. A very young child. baby

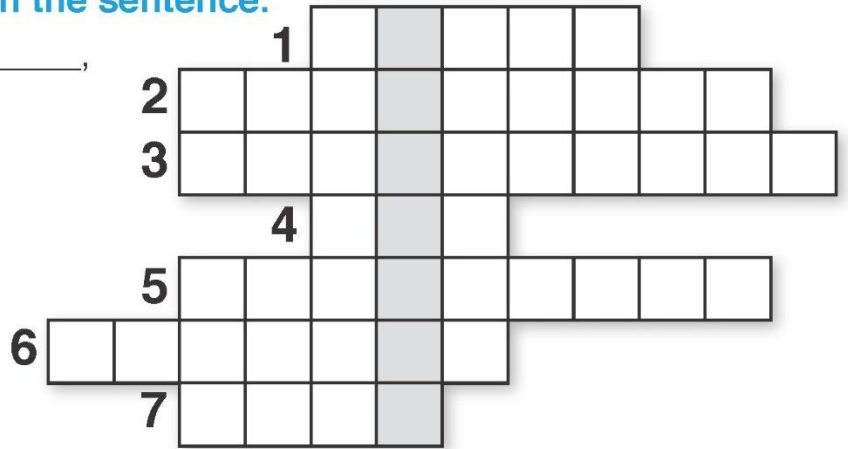

In Kuwait, you can see some of Ayoub Hussein's paintings on maney.
 1 2 3 4 5 6 7

Remember!

's	
Example: the girl's house	Example: girls' houses

6. Read. Write the underlined word with an apostrophe (') in the right place.

1. The bride moved to her husbands house after one week. husband's house
2. The girls clothes were clean. Their mothers washed them. girls' clothes
3. The artists painting was in the museum. artist's painting
4. The boys boats were made of wood. They sailed them every day. boys' boats
5. The parents house was close to their son's house. Parents' house

Unit 1

7. Describe each picture in one sentence.



1. This man is carrying a boat to the sea
2. Two women are carrying their clothes on their head
3. Some people are carrying pieces of furniture

8. Read, then draw the picture. Write.

Show a building, an animal, some people, some trees and a car, a plane or a bike. Colour the picture, then write about it.

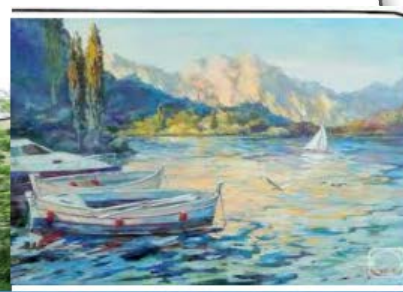

Writing

1. Write about your favourite painting.

My favourite painting is the sea. I like painting the sea very much
 I like painting the fish and dolphins. When there is a ship landing
 The view is amazing. There are some trees on the beach. Some People are swimming in the sea. The sky and the sea are clearly blue .It's the best painting I have ever painted

2. Which is your favourite picture? Write what you can see and why you like it.

My favourite picture is _____

My favourite painting is the sea .I like painting the sea
 . very much

I like painting the fish and dolphins . When there is a ship
 landing

The view is amazing . There are some trees on the
 beach .Some People are swimming in the sea . The sky
 and the sea are clearly blue .It's the best painting I have
 ever painted

An Advertisement for Kuwait

1. Answer these questions about the adverts in your Student's Book.

1. What is in the harbour in The Scientific Center?

old dhows

2. Who feeds the sharks?

The divers do that

3. Do you think they get in the water with the sharks?

Yes , they do.To feed them

4. What can you see or do in Kuwait Towers?

I can see Kuwait City. I can enjoy eating in the restaurant

5. What do you think you will see in Dickson House?

I will see old furniture and antics

6. Why do you think Failaka is famous?

Because it's got old temples and museums

2. Game. Give a friend some information. Can he/she guess the place?

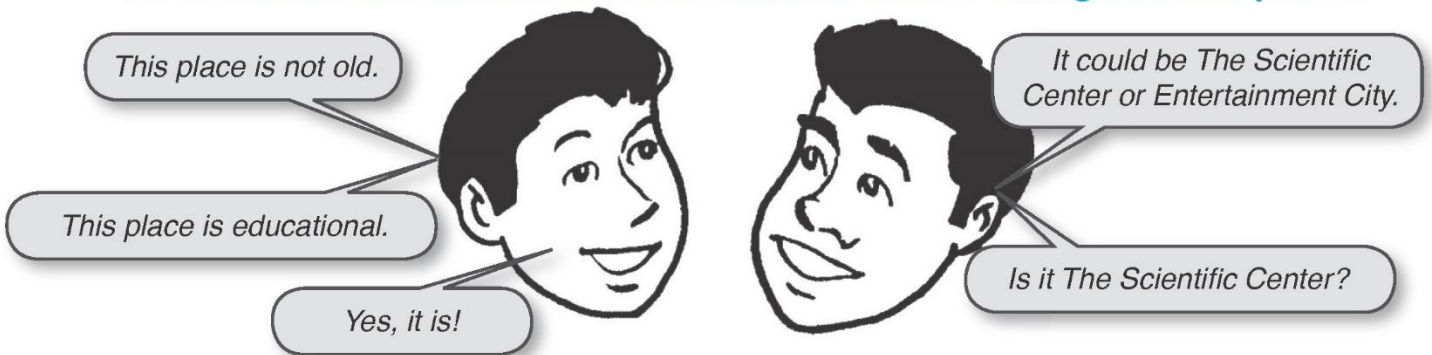

3. Write about another place you visited.

Last week, I went to somewhere. I enjoyed watching yhe
sharks and the divers there. I saw the divers while
they were feeding sharks. I also saw the old
dhows. The place was amazing. I enjoyed a lot

- If you run fast , you will win the race
 If I study hard , I will pass my exams
 If Ali sleeps early , he will get up early
 If Fatima drives slowly , she won't make an accident

Remember

First conditional

Always remember:

If I do, I will

If Simple present, Future (will)

Example

If it rains, you will get wet. (affirmative)

If it doesn't rain, you won't get wet. (negative)

4. Write the correct forms of the verbs in brackets

- If my friend invites me, I **will go** (go) to his house.
- If he **doesn't come** (not come), we will start without him.
- I will buy new shoes if I **have** (have) enough money.

5. Correct the underlined mistakes

- I will go swimming if the weather isn't good.

is

- If you ring the bell, someone won't open the door.

will

- They will hear her if she speaks very quietly.

won't hear

6. Change the following sentences into negative, make sure you keep them meaningful.

- Sara will read the e-mail today if you send it now.

Sara won't read the e- mail if you don't send it now

- If you train well, you will have a chance to win.

If you don't train well, you won't have a chance to win

- I will watch the movie if I have enough time.

I won't watch the movie if I don't have enough time

Unit 2

7. Write what you would say in the following situations

1. Your friend is visiting Kuwait and he likes high views.

Me too , that's amazing

2. Your sister asks you about your plans for the summer.

We are going to travel to Dubai this summer

3. Someone drives his car very fast.

That's very dangerous . He may hurt himself

8. Work with your friends. A tourist is coming to Kuwait for three days. Plan his holiday.

Entertainment City

Shopping

The Grand Mosque

Failaka Island

The Red Fort

The Kuwait Towers

The National Museum

Think about:

- how long it will take to visit each place
- when and where he can eat, and
- at what time he has to start in the morning.

Remember to use the words in the box.

You should ... You could ... If you ..., you will ...

Monday: You should go to the Entertainment City

it's amazing

Tuesday: You could go to the Grand Mosque

it's very spacious

Wednesday: If you like shopping, you will go to the Avenues

9. Read your plan aloud.

Complete the sentences with the words in the box.

and while because so or after that if first

1. In Kuwait you can swim in the sea _____ **or** _____ you can sit on the beach.
2. You should come to Kuwait _____ **because** _____ it is a wonderful country.
3. _____ **if** _____ you come to Kuwait, you will have great fun!
4. Shall we have chicken _____ **or** _____ fish? You choose!
5. _____ **first** _____ we'll go shopping. _____ **after that** _____ we'll go to the museum.
6. _____ **while** _____ you're walking around Failaka, you'll see some very old buildings.
7. Kuwait is a beautiful country _____ **so** _____ you should visit it.

10. Think of a place to visit in Kuwait. Find a picture. Write an advert for it.



Unit 2

1. Choose one of the two pictures and write an advert about it.

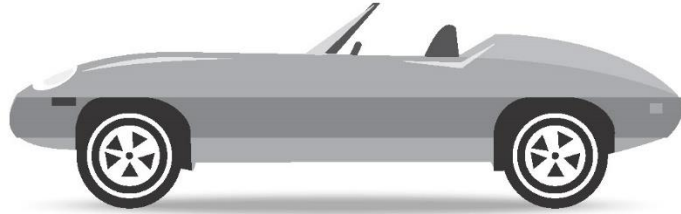

2. Write an advert for one of the pictures.

KD  _____

Name _____

We're selling I phones and accessories

What are you selling? _____

Draw a picture **A great phone**  **Big screen**

Give information **Modern Easy to use Wi Fi** **Water proof A variety of apps** **Give information**

Advanced Tech **Give information**

You can buy and exchange your device

Write NOW for more information. Send this to the address at the bottom.

Name: Ahmad Abdo

Address: 1 Mangaf, Block

Address _____

A Local Television Programme

1. Answer R (receptionist), D (doctor) or N (nurse).

- 1 Who answers the phone? **R**
 2 Who told the nurse which medicine to give you? **D**
 3 Who gives you medicine? **N**

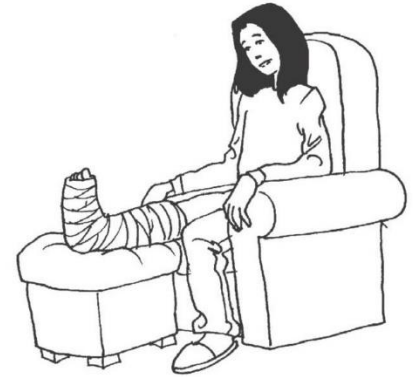

Remember

The past tense of **regular verbs**: verb + ee
 want - > wanted
 play - > played

But the past tense of **irregular verbs**
 go - > went
 swim - > swam
 cut - > cut
 put - > put

2. Complete the sentences. Use the correct form of the verbs in the box.

see meet talk tell leave hit

1. The receptionist **told** the doctor about a man.
 2. The ambulance **took** the girl to hospital.
 3. Everyone **saw** the first episode on television.
 4. She said that he **left** the hospital very quickly.
 5. A car **hit** a girl.
 6. We **met** the characters in the programme.

3. Listen to the end of the story again. Complete the paragraph.

At (1) **the** end (2) **of** the episode, the receptionist told (3) **them**, "A man has just (4) **asked** about the (5) **girl**."
 "Where is he?" asked (6) **the** doctor.
 "He's (7) **gone**," said the receptionist. "He left (8) **very** quickly."

7. Rewrite these sentences with punctuation marks from the box.

“ ” ? , .

1. My name is Sami said the little boy
My name is Sami .” said the little boy
2. A man was driving the car said the girl
A man was driving the car .” said the girl
3. When did this happen asked the policeman
. When did this happen ?” asked the policeman
4. What’s your name asked the nurse I want to phone your mother
What’s your name ?” asked the nurse .
. I want to phone your mother

Remember

- We use (because) to explain the reason behind things.

Example: I went to the restaurant because i was hungry.

- We use (so) to explain the result of things.

Example: I was hungry so i went to the restaurant.

8. Look at the last picture in the Student’s Book. Here is what the man told the police. Join the sentences.

1. I was driving along the road. I was going to work. (because)
I was driving along the road because I was going to work.
2. My phone rang. I answered it. (so)
My phone rang so I answered it.
3. It was an important person on the phone. I listened very carefully. (so)
.It was an important person so I listened very carefully
4. I was talking to the man. I didn’t see the girl. (so)
I was talking to the man so I didn’t see the girl
5. I drove home. I was frightened. (because)
I drove home because I was frightened
6. I was worried about the girl. I went to the hospital. (so)
I was worried about the girl so I went to the hospital

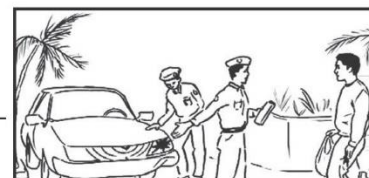

9. Discuss these questions. Work with three friends.

1. What do you prefer doing in the evenings? **I prefer watching TV with my family**
2. Which television programmes do you enjoy watching? **I enjoy watching action films**
3. What sports do you like playing? **I like playing football**

Write sentences. Use I prefer, I like, I enjoy.

Fahd and I prefer playing on the computer in the evenings, but Anwar and Ahmed prefer watching television.

Ali and I like eating pizza at Pizza Hut

My friends and I prefer

visiting the zoo on Fridays

I enjoy riding a horse

I enjoy playing in the garden too

Writing

1. Work with four friends. Think of a film. Write the information.

The name of the film:	<u>Titanic</u>
The name of the actors:	<u>Silvester Stalone</u>
Where is it?	<u>At sea</u>
Is it a love story?	<u>Yes, it's a love story</u>
Is it funny?	<u>Yes, it's funny</u>
What happens?	<u>The actor loved a girl</u> <u>They decided to marry</u>
Is the music good?	<u>Yes, it's very good</u>
How many *s?	<u>five stars</u>

2. Write a report about the film. Give it to other people in your class to read.

Titanic : a good film to watch!

. I watched a film yesterday. It was Titanic

. I watched it with my family. It was fantastic

. The hero was funny and young. He loved a girl Called Rose
They loved each other. But , they didn't marry Because the
hero drowned when he saved his girl

3. Read the film reports in the Student's Book. Then answer and complete.

1 Which film do you want to see? Film A

2 Find out if other people think the same as you.

Most people want to see film Film A because It's funny.

Read the following passage then answer the questions below:

Abdulrahman Al Sumait was born in Kuwait. He was born on October 15, 1947 and passed away in 2013. He was a physician and Islamic scholar. He studied Medicine at the University of Baghdad. Abdulrahman Al Sumait was a doctor specializing in internal medicine before working in charity work. He received more than 12 prizes and honour certificates from different organizations.



Abdulrahman Al Sumait established a human organization known as Direct Aid. In less than 30 years, Direct Aid built more than 800 schools, 4 universities, 200 medical clinics, over 200 training centres for women and 2,200 mosques. It drilled thousands of wells and constructed many agricultural projects which turned desert areas into green ones.

We learn a lot from Dr. Abdulrahman Al Sumait who spent his life serving humanity and helping the poor around the world, especially in Africa. He is known for his good deeds care and charity work.

A) Choose the correct answer from a, b, c and d:

1- The best title for the passage is

- a) Direct Aid b) A man to Remember ✓ c) Africa d) Internal Medicine

2. The underlined pronoun "which" in the second paragraph refers to

- a) Universities b) Mosques c) training centres d) projects ✓

3- The underlined word deeds in the third paragraph means

- a) actions ✓ b) interests c) tasks d) benefits

4- The main idea of the third paragraph is:

- a) Abdulrahman Al Sumait as founder of Direct Aid.
 b) Abdulrahman Al Sumait's biography.
 c) Abdulrahman Al Sumait as great man who helped the poor ✓
 d) Direct Aid is a humanitarian organization.

2. Do as shown between brackets:

1- My friend used to eat a lot of sweets. (Make negative)

didn't use to

2- Columbus discovered AMerica in 1492. (Ask a question)

When did Columbus discover America

3- If i see a fire, I **will call 112** (complete)

3. Word Search Puzzle

Find the following hidden words: aquarium - artist - broken - daughter - husband - model

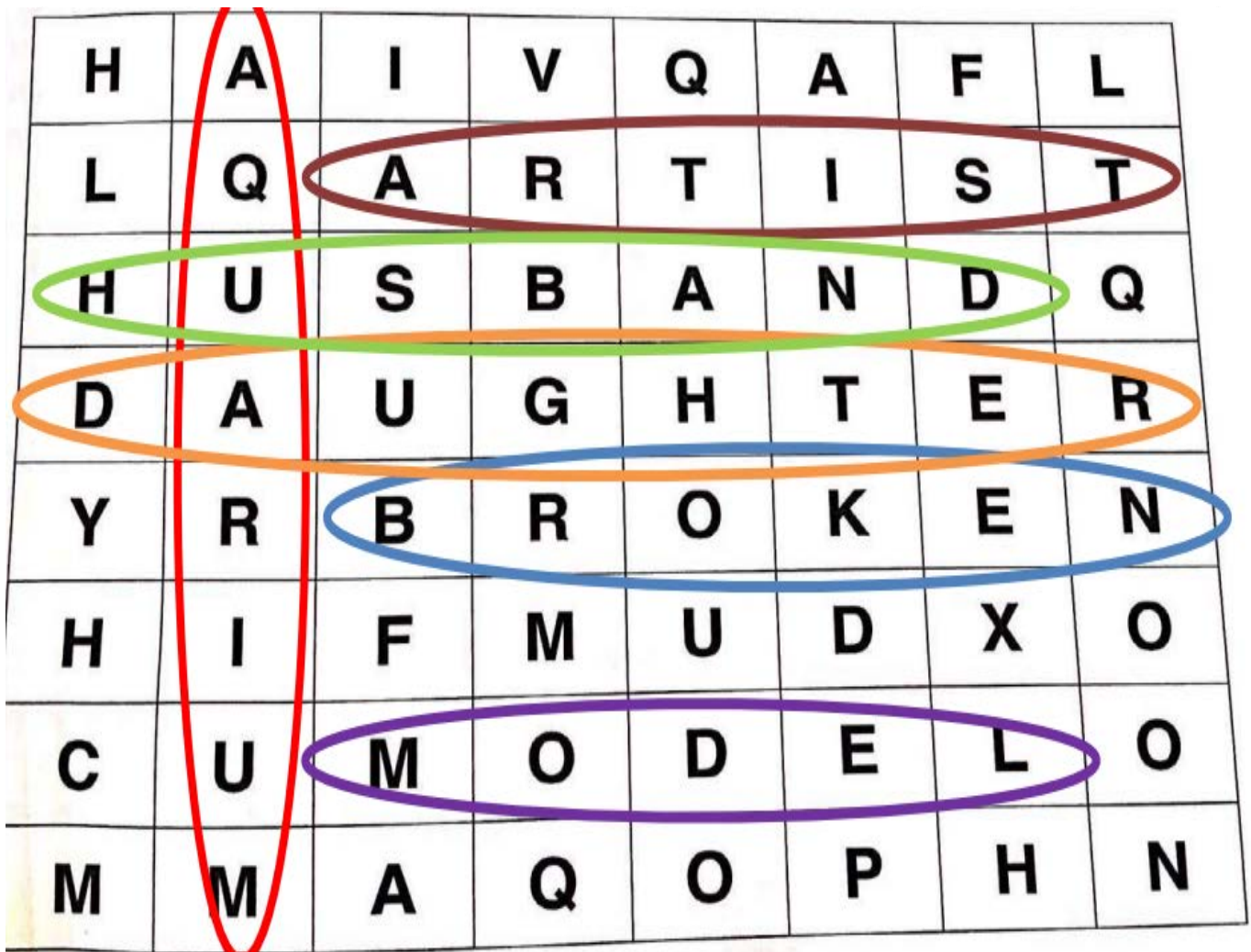

1. Use the words in the box to finish the paragraph.

expensive desalination plants factories without called little build rich

There is very (1) **little** fresh water in Kuwait. People use sea water for drinking — (2) **without** the salt! It is very (3) **expensive** to take the salt out of sea water. Kuwait is a (4) **rich** country and can (5) **build** (6) **Desalination plants**. These (7) **factories** make the sea water safe to drink. Towers around the country hold the drinking water. The towers in the photo are famous, beautiful and very useful, too. One has got a restaurant, another gives light and two of them hold enough water for all of Kuwait City. They are (8) **called** the Kuwait Towers.



2. Match the definitions with the pictures and write the words:

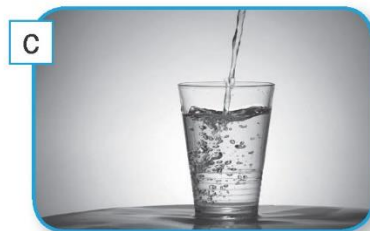

- **factory** (**b**) a place where things are made
- **lake** (**a**) a large area of water with land around it.
- **Clean water** (**c**) water which is safe to drink.

3. Match the words and pictures

1- two

2- two thirds $\frac{2}{3}$

3- one third $\frac{1}{3}$

4- one



one pizza

a



two thirds of a pizza

b



2 pizza

c

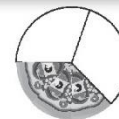

one third of a pizza

d



4. Write the opposites of these words

<p>Across →</p> <p>1. up down</p> <p>2. difficult easy</p> <p>4 hot. cold</p> <p>5. good bad</p> <p>6. dirty clean</p> <p>8. fast slow</p> <p>10. left right</p>		<p>Down ↓</p> <p>1. nights day</p> <p>3. big small</p> <p>4. expensive cheap</p> <p>7. first last</p> <p>9. cool warm</p>
--	--	---

Who or which

5. Complete the sentences. Use who or which and your own ideas

Example:
 They have to build desalination plants which are very expensive. I have got a friend who likes scuba diving.

Remember
 We use who for people.
 A journalist is someone who works for a newspaper.
 We use which for things.
 A hat is something which you wear on your head.

1. I have got a friend who gets up early in the morning
2. Kuwait is a country which lies on the Gulf
3. A giraffe is an animal which has got a long neck
4. I have got a teacher who teaches us English at school
5. There are some people in my class who always go to school on foot

6. State whether these sentences are (✓) or false (✗) and justify your answers

- 1 Everyone needs water to live.
- 2 Icebergs are easy to pull a long way.
- 3 If you pull an iceberg to Kuwait, it won't melt.
- 4 Some countries make drinking water from sea water.
- 5 You can find icebergs in the Antarctic.

7. Work it out with a friend

You need twelve pencils. Put them on your desk, like this:

8. Try this. Tell your class what happened.

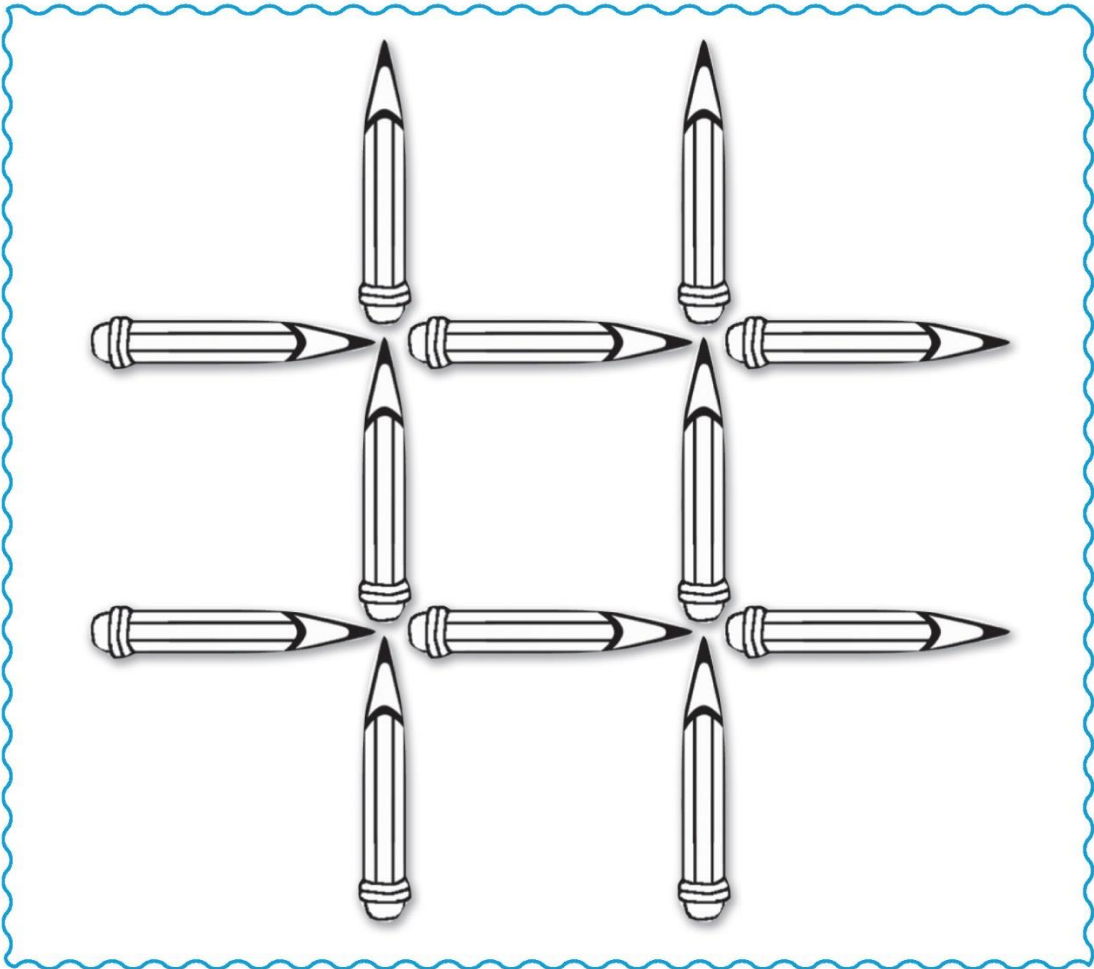

Now, move only three pencils and make three squares.
Then, tell two more friends how you did it.

Unit 4

1 Answer the questions.

How much water do you use when you clean your teeth?

Put a big bowl in the sink under the tap.

Put some toothpaste on your toothbrush.

How much water is there in the bowl?

How much water can you save each time?

x 2 – You brush your teeth in the morning and at night

How much can you save in a year?.

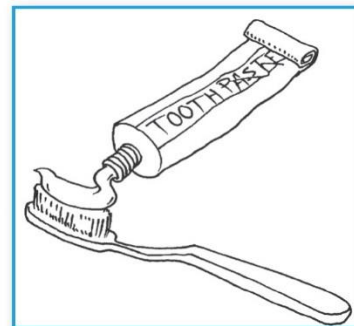

Write about what you did and what you found out.

There are three litres of water

I can save 2.0 litres of water each time

You can save 182.0 litres of water a year

10.  Listen to these words. Which letter makes no noise?

dirty third litre quarter water

11.  Listen to these words and repeat.

- | | | | |
|--------------|--------------------------|------------|--------------------------|
| 1. afternoon | <input type="checkbox"/> | 2. country | <input type="checkbox"/> |
| 3. teacher | <input type="checkbox"/> | 4. drink | <input type="checkbox"/> |
| 5. wonderful | <input type="checkbox"/> | 6. factory | <input type="checkbox"/> |
| 7. brain | <input type="checkbox"/> | 8. iceberg | <input type="checkbox"/> |
| 9. dangerous | <input type="checkbox"/> | 10. person | <input type="checkbox"/> |

12. Think about teeth. Write four words under each line.

Good for your teeth

water

brush

toothpaste

tooth pick

Bad for your teeth

fizzy drinks

chocolate

sugar

fast food

13. Look at your friend's words. Write more words.

Have you got the same words as your friend? Write two more words Under each title.

14. Make a poster about teeth. Write and draw pictures.

Look after your teeth

Always brush your teeth twice a day

Always drink water

Don't drink fizzy drinks

Don't eat much chocolate



Read about the animals on page 43 of the Student's Book again. You will find the answers there.

1- Do whale sharks eat other sharks?



No , they don't eat them

2- Which country can you see whale sharks near – Canada or Kuwait?

Kuwait . You can see them near it

3- What does a puffer fish do when it is frightened?

It drinks water to look bigger

4- Where do turtles lay their eggs?

In the sand

5- Why do people want turtle shells?

To keep them at home as decorations

6- Where do butterfly fish live?

In coral reefs

2. It's Quiz time!



Name the animals which		
Lay eggs	Eat other animals	Live on a farm
Turtles	lions	cows

3. Name three wild animals

Tiger - Elephant - Monkey

4. Listen to these words. Which letter makes no noise in each.

shipwreck pattern whale

5. Underline the letters which make no noise in these words. Listen. Are

- 1. frighten
- 2. when
- 3. lamb
- 4. knife
- 5. cupboard
- 6. biscuits
- 7. metre
- 8. chocolate

6 Can you see the sentences? Write them.

- 1 some sharks are very dangerous and can eat people
Some sharks are very dangerous and can eat people
- 2 there is a shipwreck close to qaruh
there is a shipwreck close to Qaruh
- 3 some people have found treasure on shipwrecks
Some people have found treasure on shipwrecks

7. Word search exercise. Find the word.

- Shark
- Buffer fish
- Squid
- Turtle
- Starfish
- Octopus
- Whale

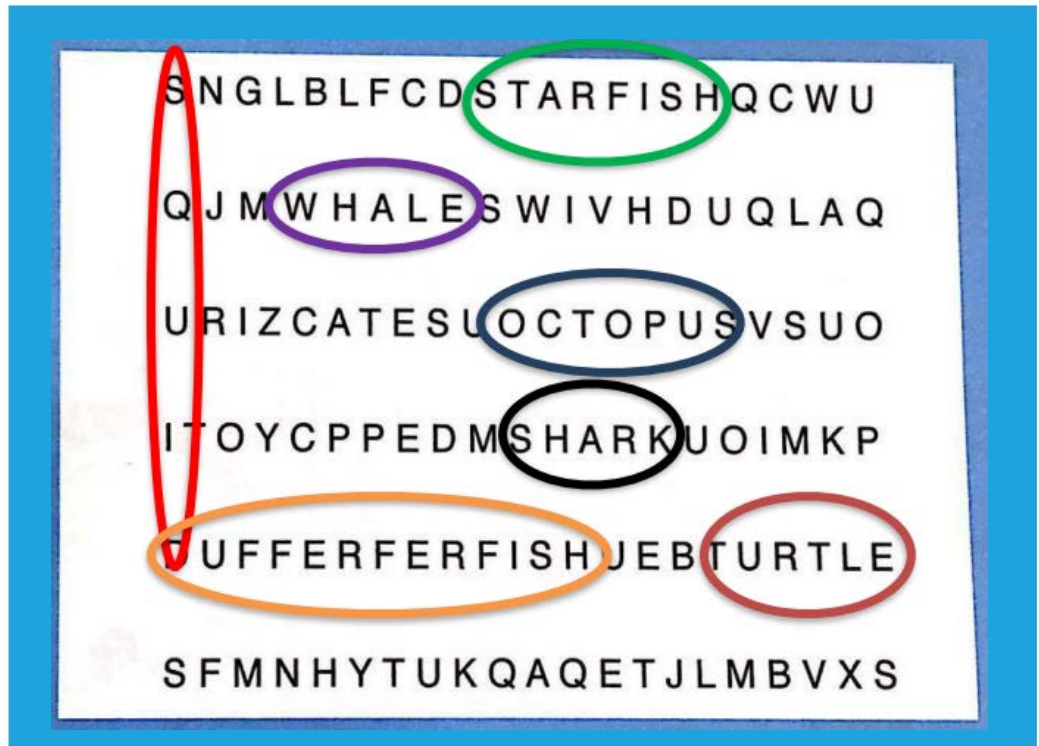

7. Write the sentences.

Example:

I/walk on the beach/when/meet my friend

I was walking on the beach when I met my friend.

1 They/drive along the road/when/a dust storm/start

They were driving along the beach when a dust storm started

2 The ship/sail near the beach/when/hit a rock

The ship was sailing near the beach when it hit a rock

3 The students/work quietly/when/principal walk into the room

The students were working quietly when the principal walked into the room

4 My mother/shop/when/my father phone her

My mother was shopping when my father phoned her

Remember

- We use the past continuous for the action that was in progress.
- We use the past simple for the completed action.

Example:

"I was watching TV when somebody knocked at the door."

8. Who said it? Match the pictures and the sentences.

1 Oh, isn't that beautiful! **b**

2 Oh no, I must get away quickly! **c**

3 Sh, it's laying its eggs. **d**

4 I want to do that again. **a**

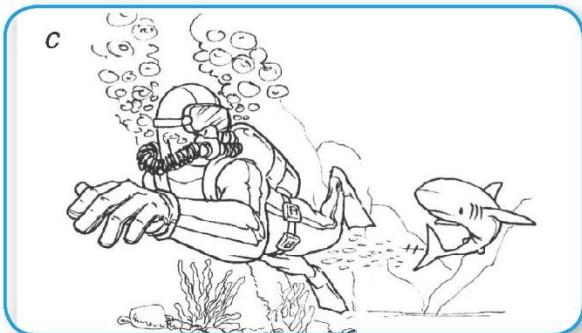
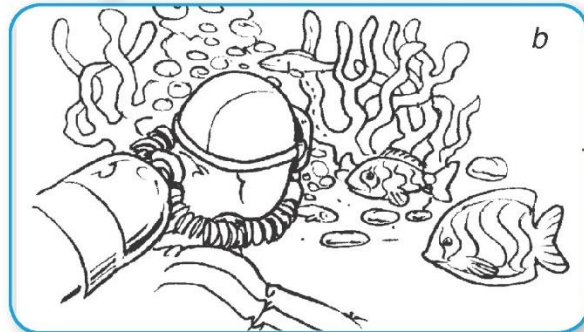
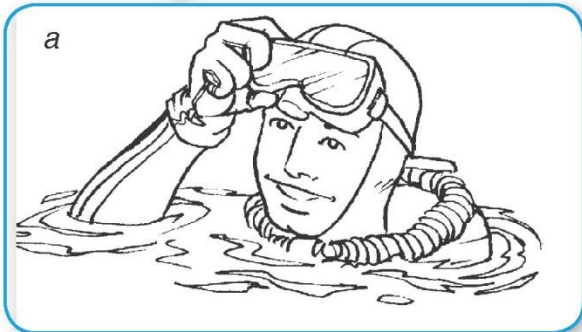

9. Choose the correct word.

- 1. Sharks (has/have) very sharp teeth.
- 2. There (is/are) shells on the beach.
- 3. A baby whale (need/needs) a lot of milk.
- 4. Some fish (look/looks) beautiful.
- 5. The sea (is/are) a very dangerous place.
- 6. Whale sharks (doesn't/don't) eat people.
- 7. Squid (have/has) ten legs.
- 8. Turtles (lay/lays) their eggs in the sand.

- _____ have
- _____ are
- _____ needs
- _____ look
- _____ is
- _____ don't
- _____ have
- _____ lay

Writing

10. Choose and write.

<p>Choose an animal which lives in the sea.</p> <p>Find out about it.</p> <p>Write a paragraph about it.</p> <p>Draw a picture.</p>	<p>Tell us:</p> <ul style="list-style-type: none"> - where it lives - what it looks like - if it is dangerous - how big it is - if you have seen one. - what it eats
--	---



My favourite sea animal

Write it!

Draw it!

My favourite sea animal is a dolphin. I like it very much. The dolphin lives in sea water. It looks very beautiful. It isn't dangerous. It's big. It eats plants and small fish. If I see a dolphin, I will be very happy



Writing

1. Write a plan for your story: Treasure Tree.

Setting (the place): <i>Where? When?</i>	Garden, last weekend
Characters (the people): <i>Who? What are they like?</i>	My family. Father and mother
Plot (what happens) Beginning:	My family went to the garden last weekend
Middle:	I found a treasure
End:	My father took it to the police station and was thanked for his effort

2. Write some words you want to use in your story.

Verbs	Nouns	Adjectives
go	treasure	honest
spend	tree	happy
play	police	nice
find	reward	fantastic

3. Use your plan to write your story.

Last weekend, I went to the park with my family
My father brought food and drink . I played wit my sisters
around a tree. The tree was very big and old While we were
playing, I saw an old bag. It was a treasure. The bag was full
of gold and diamond My father took the bag and went to the
police station The chief officer welcomed us and thanked
us a lot. He gave my father a reward We felt very happy

1 Read the titles of the newspaper stories. What do you think they are about?

1

Tired driver

2

No bread today

3

Where are our phones?

2 Now match the titles and the stories.

a



Last Tuesday, four teachers lost their phones at a school in Kuwait City. The police looked round the school and asked a lot of questions but they could not find the phones. "Someone must be coming into the school, taking the phones and selling them," a policeman told me.

b



Last Wednesday, a new driver was driving along the road when he fell asleep. He drove into another car. Fortunately, the drivers were not badly hurt. Both of them were taken to hospital.

c



Worried people phoned firefighters when they saw smoke coming from a bakery last Thursday. The firemen arrived in ten minutes and put the fire out. The baker was not hurt. He said, "We'll make bread tomorrow but there won't be any today."

3 Answer these questions. Write a, b or c.

1. Which story happened at the weekend? c
2. In which story did two people get hurt? b
3. Which story is about food? c
4. In which story did they use an ambulance? b
5. Which stories happened at work? a , c
6. Which story are the police still working on? a

4 Find the past tense of these verbs in the stories.

- | | | | |
|----------|------------------|---------|-----------------|
| 1. lose | <u> lost </u> | 2. tell | <u> told </u> |
| 3. is | <u> was </u> | 4. fall | <u> fell </u> |
| 5. drive | <u> drove </u> | 6. see | <u> saw </u> |
| 7. put | <u> put </u> | 8. say | <u> said </u> |

5. Write these words with -ing in the correct column.

play have climb listen swim fall run give write win

walk + ing = walking	come + ing = coming	hop + ing = hopping
playing	having	swimming
listening	giving	winning
falling	writing	running
climbing		



Remember

You can use while with past continuous.

Example:

While Ali was playing tennis, he fell down

While they were doing homework, their father came in.

6. Use the words in the box to finish the sentences.

walk watch swim listen cut

- Hamad found some shells while he was walking along the beach.
- The lights went out while they were watching TV
 - Kamel heard some beautiful music While he was walking
 - Nadia and Nadra both wore goggles While they were swimming
 - Basma hurt her finger While she was cutting onion

7. Tick (✓) the sentences you hear. Then say them to a friend.

- | | |
|--|---|
| 1 a You run very fast. <input checked="" type="checkbox"/> | b You ran very fast. <input type="checkbox"/> |
| 2 a I said, 'but'. <input type="checkbox"/> | b I said, 'bat'. <input checked="" type="checkbox"/> |
| 3 a That's a big cut. <input type="checkbox"/> | b That's a big cat. <input checked="" type="checkbox"/> |
| 4 a Did you say 'fun'? <input checked="" type="checkbox"/> | b Did you say, 'fan'? <input type="checkbox"/> |

8. Read the sentences and write them in order.

- a) He saw a young boy who was drowning. ۳
- b) After this, he got an award. ۶
- c) While he was walking along the beach, he heard a scream. ۲
- d) Then he brought him safely back to the beach. ۵
- e) He quickly jumped into the sea and swam to the boy. ۴
- f) One day Waleed was at the beach with his family. ۱

1. _____
2. _____
3. _____
4. _____
5. _____
6. _____

9. Complete the sentences with words from the snake.



- 1 If you cannot swim, you might ___ **drown** ___ in the water
- 2 If you do something very brave, you might get an ___ **award** ___.
- 3 The young boy was safe because Waleed ___ **saved** ___ him.
- 4 In a television ___ **show** ___ people might sing or talk to each other.
- 5 If you have a ___ **problem** ___ you sometimes don't know what to do.

10. Read the story about Saif and Faris. Six things are different from your Student's Book. Circle them.

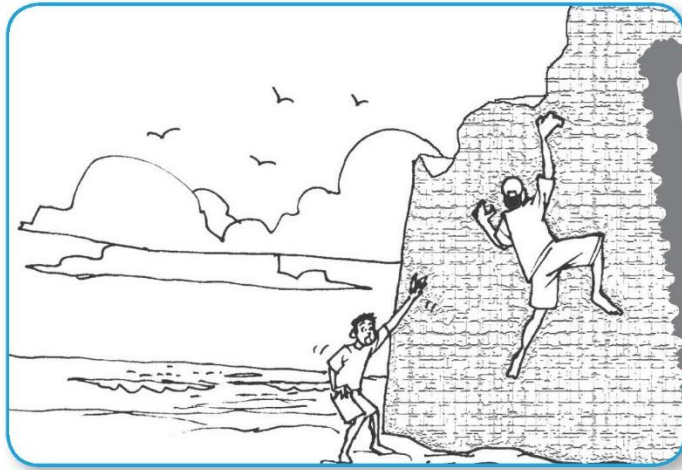

Last week Saif and Faris went to the beach. They saw a wall. Faris wanted to climb it. He fell off and broke his arm. Saif's mother phoned for an ambulance. Faris stayed in hospital for a month.

11. This story is not very interesting. Can you make it better?

Last week Saif and Faris went to the beach because **It was Saif's birthday** _____ (Was it a holiday? Was it Saif's birthday?) They took **Food and drink** _____

_____ (Did they take a ball? Did they take food or a drink?)

While they were running on the beach, they saw a wall.

There was an apple tree (What was on the other side? A fruit tree? A tennis court?)

Faris wanted to climb it because **He wanted to eat an apple** _____

_____ (Did he want to jump into the water? Did he want to see something) The wall was not safe and Faris fell and broke his arm.

He **He screamed and didn't move**

_____ (What did he do next? Did he scream? Did he move?)

Saif's mother phoned for an ambulance and _____

Saif waited with his friend for an hour _____

(How long did they wait for the ambulance?) Faris stayed in hospital for a month

and **Faris got better. Saif visited him** _____

_____ (Finish the story.)

1. Read these headlines. What happened? Use your own ideas. Write sentences. Remember to answer these questions.

Who? Where? When? What happened? What happened in the end?

1 Report says children watch too much television

2 MAN GIVES MILLION AWAY

3 Diver finds huge pearl

4 Kwait gives money to poor country

5 Police find lost child

1. **A driver found a huge pearl**

2. **The diver was diving in the sea**

3. **He went diving last week**

4. **The driver was looking for a shipwreck when he found an old box. He opened**

it and found a huge pearl inside

5. **He sold it and got two million dollars**

2. Write the full story of a fireman who saves a girl from a fire (SB p53).

Remember all the information

While / When

From a, b, c, and d choose the best answer:

- 1. While the boy, his pencil broke.
 a) writing b) wrote c) **was writing** ✓ d) writes
- 2. The children were watching television when they asleep.
 a) falls b) **fell** ✓ c) fallen d) was falling
- 3. Ali saw his friend while he to work.
 a) walks b) **was walking** ✓ c) walking d) walked
- 4. I was playing tennis when I my leg.
 a) **hurt** ✓ b) was hurting c) hurting d) hurts

Water Quiz True / False

A) Decide whether the following statements are True or False:

- | | T | F |
|---|-------------------------------------|-------------------------------------|
| 1. Potable water is drinkable water. | <input checked="" type="checkbox"/> | <input type="checkbox"/> |
| 2. Water exists naturally in the form of a gas, a liquid and a solid. | <input checked="" type="checkbox"/> | <input type="checkbox"/> |
| 3. Our human bodies are mostly water. | <input checked="" type="checkbox"/> | <input type="checkbox"/> |
| 4. A reservoir is a man-made lake used for water storage. | <input checked="" type="checkbox"/> | <input type="checkbox"/> |
| 5. The earth naturally recycles water faster than we can use it. | <input checked="" type="checkbox"/> | <input type="checkbox"/> |
| 6. Most plants do not die from over watering. | <input type="checkbox"/> | <input checked="" type="checkbox"/> |

B) Surf the net to check your answers

1) Match the definitions with the appropriate pictures:

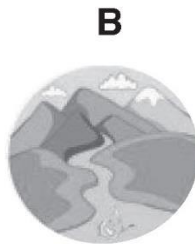
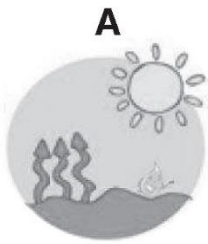

- 1- It happens when much water in the clouds falls back to earth.
- 2- Water vapour changes into clouds.
- 3- Water turns into vapour.
- 4- When water collects back into lakes, rivers or seas.

A	B	C	D

2. Complete the following diagram with information about the water cycle:

Use the sentences in the diagram and the following linkers (First, Then, Next, Finally) to write a paragraph in your notebook:

Topic sentence

.....

.....

Supporting Detail 1

.....

.....

.....

.....

Supporting Detail 2

.....

.....

.....

.....

Supporting Detail 3

.....

.....

.....

.....

Supporting Detail 4

.....

.....

.....

.....

Concluding Sentence

.....

.....

Unit 7

3. Use the words and pictures to write sentences in the passive following the example:

1- Goals/ score/ football

Goals are scored in football.

2- Zebras / keep/ zoo

3- A doctor / see / hospital

4- Books/ read/ library

5- Old coins and pots/ find/ museum

6- Fruits/ and vegetables/ buy/ market

7- Stars/ see/ sky

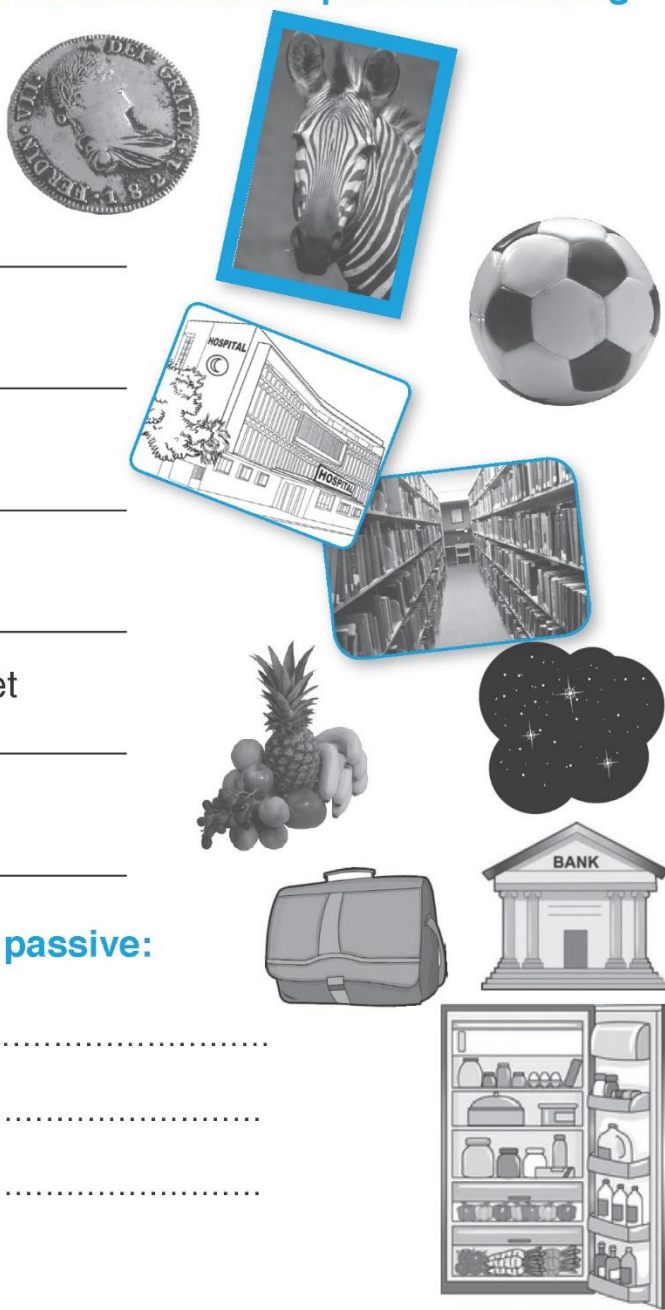

4. Complete the sentences using the passive:

Money

food

Books

Remember

In active sentences

(Thing doing action) + (verb) + (thing receiving action)

example: **Huda cleans the dishes.**

In passive sentences, the thing receiving the action is the subject of the sentence and the thing doing the action is optionally included near the end of the sentence.

(Thing receiving action) + (be) + (past participle of verb) + (by) + (thing doing action)

example: **The dishes are washed by Huda.**

5.  Listen and say the words.

shapes noses pictures

6.  Write each word in the correct place. Listen. Are you right?

eyes noses ducks ears lines pictures
cups exercises shapes dishes minutes

-s sound	-iz sound	-z sound
shapes	noses	pictures

7. Name these shapes.

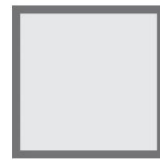
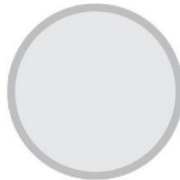
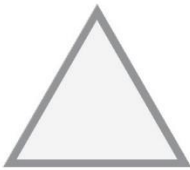

t

c

s

8. Look and draw a fun picture.

Look at picture D on page (62) of your Student's Book. Use one of these shapes to make your own fun picture.



Unit 7

9. Read, do and make.

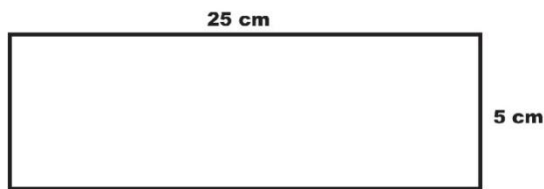
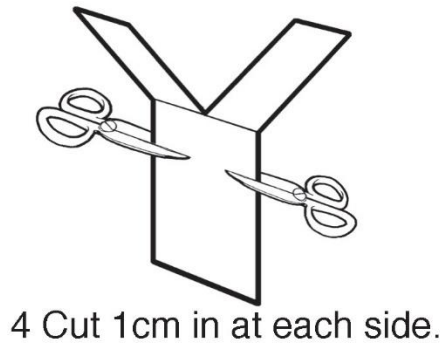
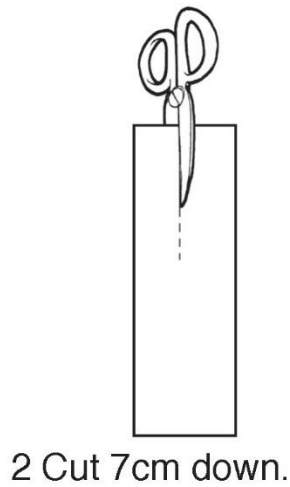

1 Get some paper 25cm x 5cm.

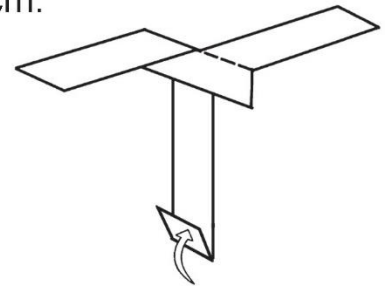
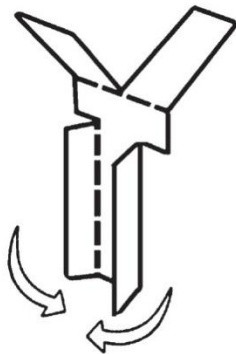

7 Hold it up. Open your hand.
What happens?

10. Complete the table:

First
Second
Third
Fourth

11. What did you need to do the experiment?

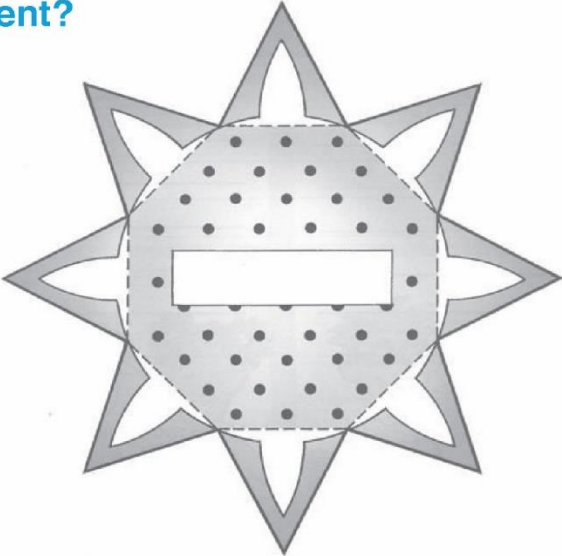

12. Write about the experiment. How is it done?

First, the picture is copied

13. What happened? Choose the correct word.

The shape opened/ closed.

14. Why do you think it happened?

Science in our Life

1. Look at page 65 of your Student's Book. Correct these false sentences.

1. Many rich countries do not have safe drinking water.

2. It is very cheap to make clean water in Kuwait.

3. A poor old man has invented the LifeStraw.

5. You can only use the LifeStraw to drink from lakes.

4. The LifeStraw is made of wood.

2. Write sentences about the pictures.



A knife is used for cutting bread, meat, etc.

1



2



3



4



5



Remember

To be used + for + Verb + ing

A pen is used for writing

3. Talk to your friends about next weekend. Complete the table. Write sentences.

Name	will	won't	might
Me			

Have you got any plans for this weekend, Nura?

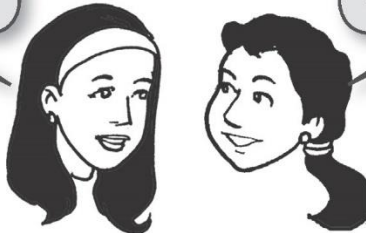

Well, I might go shopping. I won't watch any TV but I will play tennis.

Nura might go shopping. She won't watch any TV but she will play tennis.

ME: _____

Friend 1 _____

Friend 2 _____

4. Work with a friend. What jobs could these pupils do when they leave school?

Name: Nadia
Good at: Arabic, English
Likes: looking after children

Name: Bader
Good at: football
Likes: football

Name: Maha
Good at: Maths and Science
Likes: helping people

Name: Sami
Good at: Geography, English
Likes: planes

Remember

Use will to talk about the things that will happen for sure.

Use won't to talk about things that are not going to happen.

Use might and could to talk about the things that may or may not happen.

5. Complete the crossword.

Across →

2 The LifeStraw is made of _____.

4 The opposite of cheap.

5 Very, very small living things.

You can't see them – some are dangerous.

7 You can drink through this.

8 This can be sunny, hot, cold, rainy, etc.

Down ↓

1 A person who studies or teaches science.

3 A very large piece of ice that you can see in the sea.

6 Electricity, etc. makes this.

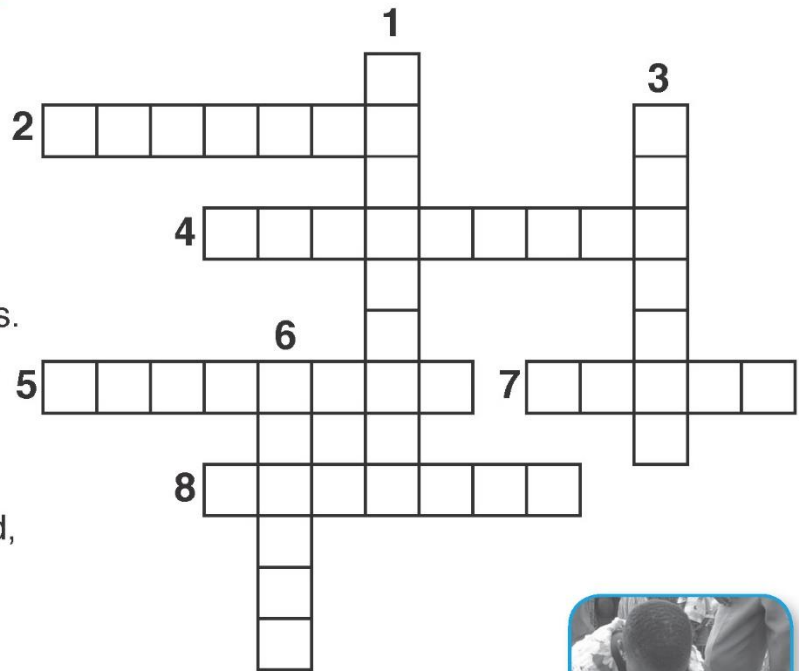

6. The underlined letters all have the same sound. Listen and repeat.

flood

country young eough

dust fuunny brush

colour done glove



Say these sentences.

1. Dan has brushed the dust away.
2. Have you got a hat and some gloves?
3. We have never had a flood in our country.
4. That's a funny colour!



7. Questionnaire: Are you saving energy?

Yes

No

	Yes	No
1- Are all your light bulbs energy-saving?		
2- Do you remember to turn lights off?		
3- Do you keep the air conditioner down?		
4- Do you switch appliances off?		
5- Do you fix dripping taps and showers?		
6- Do you leave tap on when you brush your teeth?		
7- Do you walk to school?		
8- Do you have more than one car?		
9- Do you use solar energy?		

8. Compare your answers with your friend's. Who is more interested in saving energy?**9. How can you save energy? Use the ideas in the previous task to write a paragraph about saving energy.**

Your paragraph should have a topic sentence and supporting details.

9. Ahmed went on a visit to Failaka Island. Read his report.

Our class visit to Failaka

Last week my class went to Failaka Island to visit the museum and look at the old buildings. (1)

First we got a bus from our school to the harbour. Then we got a boat to Failaka Island. (2)

When we arrived, we went to the museum. (3) It was very interesting.

Then it was lunch time. We sat down together and ate. (4) We talked to each other about the island while we were eating.

After lunch, we walked round the old buildings on the island. Suddenly, Faisal called out and we all went to see what he had. He was holding a beautiful earring. (5) Just then, a tourist came up to him.

It was her earring. (6)

Finally, we went home – very tired but very happy.

10. Ahmed's report needs more information. Put a to f in the correct places.

- a) Faisal was very sad it wasn't very old but the tourist was really happy.
- b) Our teacher told us a lot about it so we were very excited.
- c) He asked the teacher if it was very old. He wanted to take it to the museum.
- d) The sea was not rough and the sunshine was warm. It was a lovely day.
- e) We all brought different food to eat and it was delicious.
- f) A man told us about old coins, pots and bottles which they sometimes find there.

11. Write your own report about a visit.

1 Choose the right word to finish each sentence.

- 1 Al-Khawarizmi was born in about **(780/1978)**.
- 2 He lived in **(Kuwait/Baghdad)**.
- 3 He was born in **(Baghdad/Khawarizm)**.
- 4 He was an **(author/artist)**.
- 5 He was best known for **(stamp collecting/ algebra)**.
- 6 He was very interested in **(geography/history)**.
- 7 He made the first map of **(Baghdad/the world)**.



2 Answer these questions about you.

1 When were you born?

2 Where were you born?

3 Where is your home now?

4 Where was your grandpa's home when he was a child?

5 What are you interested in?

3 Now ask and answer the questions from Exercise 2 with a friend.

4. Exchange books with a friend. Use question tags to make sure the information from Exercise 2 is correct.

You were born in Kuwait City, weren't you?

5.  Listen to the past tense of these verbs. Write them in the correct place.

ask want play like climb open
look arrive point brush land need

/d/	/t/	/id/
<i>played</i>	<i>asked</i>	<i>wanted</i>

6. Write question tags and answers with the words.



1. go to Failaka Island last weekend

2. eat eggs for breakfast this morning

3. do Maths homework yesterday

4. read a book about Al-Khawarizmi last week

Remember

Question tags are short questions at the end of statements.
 - A **positive statement** is followed by a **negative question tag**.
 Jack is from Spain, isn't he?
 - A **negative statement** is followed by a **positive question tag**.
 They aren't funny, are they?
Don't forget to use the proper pronoun instead of the noun

7. Write the words.

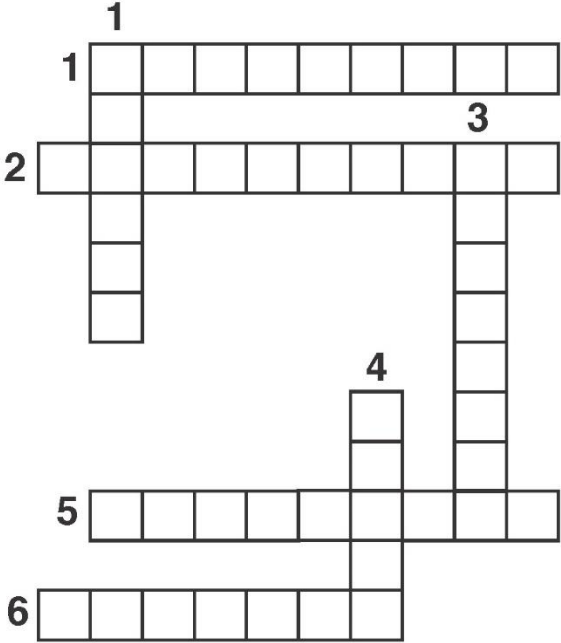

Across →

- 1. Marie Curie won her second important prize in _____.
- 2. You go here to study when you have finished school.
- 5. Marie Curie was this.
- 6. Marie and Pierre Curie won an important prize for this in 1903.

Down ↓

- 1. The Curies worked to find a cure for this.
- 3 Marie Curie’s parents were both _____.
- 4 You study algebra in _____.

8. Choose the correct answers. Write the letters in the boxes.

When you write the letters, you will find the name of Marie Curie’s child. She also won an important prize.

- 1 Marie Curie (is born [S]/was born [I]) in 1867.
- 2 Her parents (were [R]/was [U]) both teachers.
- 3 Marie (works [S]/worked [E]) hard at school.
- 4 Marie (studied [N]/studies [A]) Physics and Maths.
- 5 She (meets [N]/met [E]) Pierre Curie in 1894.

Five empty boxes for writing letters.

11. Think of inventions that start with the following letters:

C:	_____
P:	_____
R:	_____
T:	_____

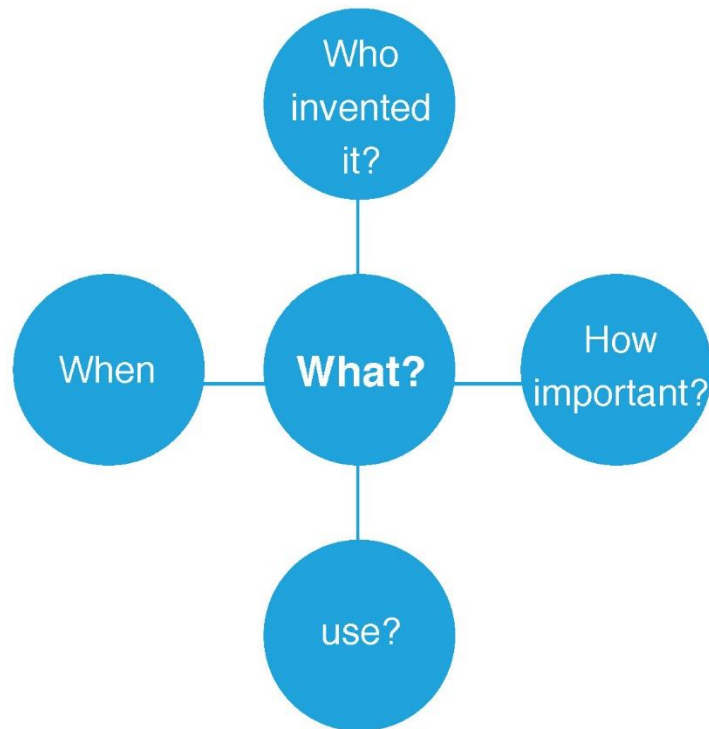
10. Which invention is according to you the most important? Surf the net to find out information to complete the following spider-gram:**11. Develop your notes into a well-structured paragraph.****Remember**

- the topic sentence.
- the supporting details.
- punctuation marks.

Write the topic in your note book.

12. Choose a person to write about.

The person can be famous, or someone you know.

13. Write questions about the person.

Use the question words and add two more questions.

Who? _____
What? _____
Where? _____
When? _____
How many? _____
Why? _____

14. Write about the person. Answer all the questions you have written.

15. Read to your friend. Can he/she guess who you wrote about?

Progress Check

Read the following text to answer the question below:

Pure water is a clear, colourless, odourless and tasteless liquid. All living creatures need water in order to survive. Forty to ninety percent of the weight of all living organisms is water. The human body needs water to get rid of wastes and to transport nutrients throughout the body.

Ancient Scientists thought of water as a basic part by which all other liquids are measured. At the end of the eighteenth century, a British chemist made water by using a mixture of hydrogen and oxygen. We now know that water consists of two parts hydrogen, the most abundant element in our world, and one part oxygen, the element that we breathe in order to survive.

Choose the right answer:

- 1- The main idea of the text is the importance of

a) the human body	c) oxygen
b) hydrogen	d) water

- 2- The word "abundant" in line 8 means:

a) present in small areas	c) present in great quantity
b) present in different shapes	d) present in small amount.

- 3- The opposite of the word "survive" in line 2 means

a) use	c) die
b) measure	d) breathe

4. Which of the following is true?

- a) Water smells like apples.
- b) Water smells like orange juice.
- c) All living things need water in order to survive.
- d) None of these

5. What percentage of your body weight is water?

- a) 30%
- b) 10%
- c) 70%
- d) 95%

II. Language.**A/ Do as shown between brackets:**

1. we send the e-mails in the morning. (Make passive)

2. I drink one bottle of water daily. (Make negative)

3. Adel is from Kuwait,? (Complete with a tag question)
4. He isn't from Britain,? (Complete with a tag question)
5. Tomorrow is Friday. we (**will-won't**) go to school. (Choose the correct answer)

Unit 9

B. Crossword

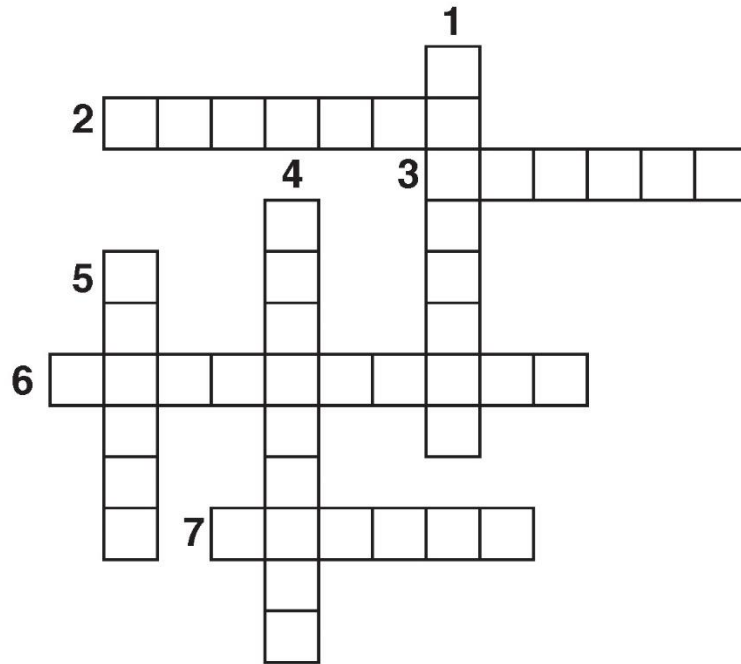

Across →

2. maths which uses letters and signs.
3. not dirty
6. a place where students can go to study after leaving school
7. a thing in which you can see yourself

Down ↓

1. very small living things which can make people ill
4. when one person asks another person questions
5. a very bad illness

1. Tick the things you need for each sport.

	ball	bat	racket	net	goggles	football boot
1. football	✓					✓
2. table tennis						
3. tennis						
4. swimming						

1. You need a ball and football boots for football.

2. _____

3. _____

4. _____

2. Read the letter and number the fish.

Hi Mona,

I love scuba diving. Last week we saw three fish. Here is a picture of them. The first one had very big eyes but it wasn't very big. It looked beautiful. The second one was very fat with small eyes. It looked funny. The third one was long like a snake. It looked sad.

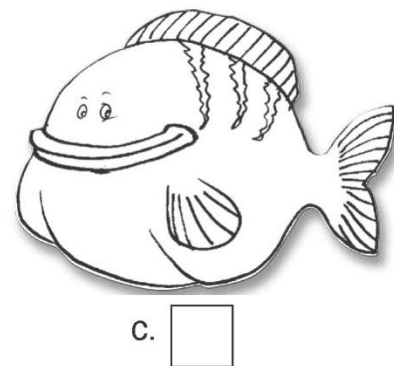
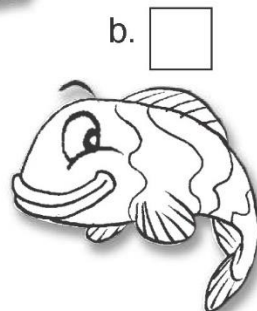
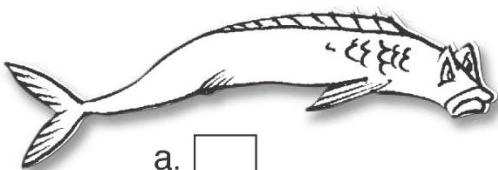

3. Finish the sentences with the correct form of the verbs.

1. I _____ to my grandmother this evening. (write)
2. My friend _____ a very good story last week. (write)
3. We _____ Failaka Island next weekend. (visit)
4. We _____ Dickson House in our last holiday. (visit)
5. My mother _____ me some new shoes tomorrow. (buy)
6. My brother _____ a computer last weekend. (buy)

4 Write the sports words.

The crossword puzzle grid consists of the following words to be filled in:

- Across:**
 - 1: 10 letters
 - 5: 6 letters
 - 6: 6 letters
- Down:**
 - 2: 10 letters
 - 3: 4 letters
 - 4: 10 letters

Across →

1. You need a bat, a ball, a table and a net for this sport.
5. You need snow for this sport.
6. You go under the water in this sport.

Down ↓

2. Tall people can play this sport.
3. You need a racket, a ball and a net for this sport.
4. You get wet when you do this sport.

Remember

We use to be + going to + verb (inf.) when:

1. We want to talk about a planned action for the future.

I am going to visit you on Wednesday.

2. We are making a prediction.

It is really cold. I am sure it is going to snow tomorrow.

5.  Listen and say.

swimming playing writing going

6.  Listen and tick (✓) the correct sentences.

- | | |
|---|--|
| 1. a I swim in the sea. | b I'm swimming in the sea. |
| 2. a I write stories in my book. | b I'm writing stories in my book. |
| 3. a We play in a team. | b We're playing in a team. |
| 4. a We're going to have a picnic. | b We go and have a picnic. |

7. Finish the sentences with a sport.

- I like _____.
- I don't like _____.
- My friend's good at _____.
- I'm not good at _____.

Remember
(like / good at) are followed by
verb + ing

It's quiz time!

8.  Listen and guess the sport.

- _____
- _____
- _____
- _____



9. Finish the table about your upcoming visit to a country.

The country I'm going to visit	Who I'm going to go with and how long I'm going to stay	What I'm going to do and see there

10. Use the information in the table to write to a friend.

Remember

- 1. Use the correct beginning.
- 2. Think about your first sentence; the reason for writing.
- 3/4. Organize your ideas; one paragraph for each main idea.
- 5. End the e-mail.

This message has not been sent.



Subject:

①

②

③

④

⑤

11. Write notes about yourself.

Name: _____

How old you are: _____

Number of brothers: _____

Number of sisters: _____

Father's job: _____

Mother's job: _____

Pet: _____

Pet's name: _____

School big or small: _____

Number of pupils: _____

Favourite school lesson: _____

Sports you play: _____

12. Write to your new friend.

Use the notes you have written. Write a first e-mail to your new friend.

13. Type the e-mail using your smart device and send it to your friend.

A Beautiful Country

1. Work in pairs. Match the pictures and the sentences.

Come to New Zealand – an exciting country

1. There are lots of sea animals and birds. You can go out in a boat and watch the animals swimming in the sea.

a

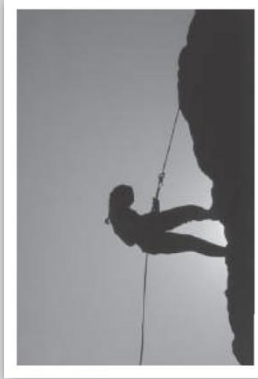

b



2. Mount Cook is a very high mountain. Some people like to climb it but it is very difficult. Walk around the National Park instead – it's easier! It's very beautiful.

c



3. Do you want to see what is in the sea around New Zealand? Try scuba diving off the east of North Island. You can see some beautiful fish.

d



4. Finally, from June to October there is a lot of snow, so you can go skiing. Some of the best skiing is on the mountains on South Island.

2. Make sentences.

Example:

Oman is bigger than UAE.

UAE is bigger than Kuwait.

Oman is the biggest.

1. The rabbit is faster than the cat.

The cat is

The rabbit

2.

.....

.....

3.

.....

.....

Remember

Short adjectives ending in vowel + consonant, remember to double the final consonant before -er/ -est. **big → bigger → biggest**

If the adjectives ends in -e, just add -r or -st. **wise → wiser → wisest**

With adjectives ending in y, you change the y to i and add er/ est.

happy → happier → happiest

big → bigger → biggest



fast → faster → fastest

Animal	Speed (mph)
rabbit	35
cat	30
mouse	8

old → older → oldest

Name	Age
Nasser	12
Nora	10
Khaled	8

heavy → heavier → heaviest

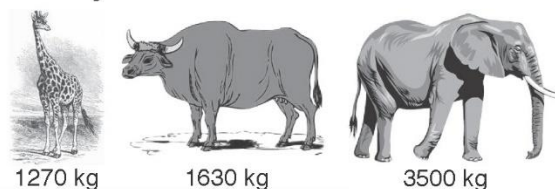

3. Complete the table





Short adjectives	-er	-est
hot		
lucky		
large		

4.  Listen and write the number of syllables in each word.

Hospital has **three syllables**:
hos – pi – tal

- | | | | |
|---------------|--------------------------|----------------|--------------------------|
| 1. airport | <input type="checkbox"/> | 2. beach | <input type="checkbox"/> |
| 3. city | <input type="checkbox"/> | 4. volcano | <input type="checkbox"/> |
| 5. population | <input type="checkbox"/> | 6. island | <input type="checkbox"/> |
| 7. beautiful | <input type="checkbox"/> | 8. interesting | <input type="checkbox"/> |

5. Match the signs and the directions.

a. 	b. 	c. 	d. 
--	--	---	--

- | | | | |
|-------------------------|--------------------------|-------------------|--------------------------|
| 1. turn right | <input type="checkbox"/> | 2. turn left | <input type="checkbox"/> |
| 3. go past the hospital | <input type="checkbox"/> | 4. go straight on | <input type="checkbox"/> |

6. Start at the school. Read and then draw Ahmed's house on the map.

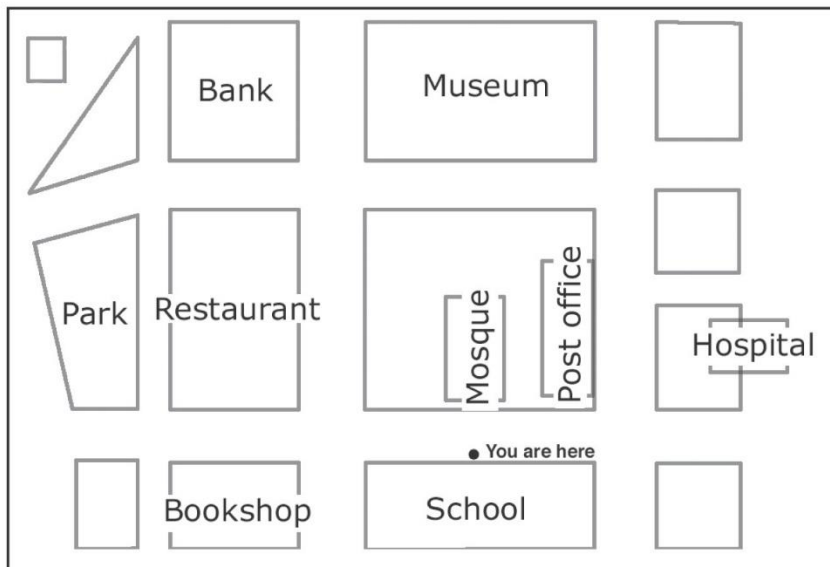

Go out of the school and turn left. Walk straight on. Go past the bookshop on your left and the restaurant on your right. Take the next right. Go past the park and turn left. Ahmed's house is on the right.

9. Work in pairs. Look at the picture. Tick the words you can use to describe the picture.

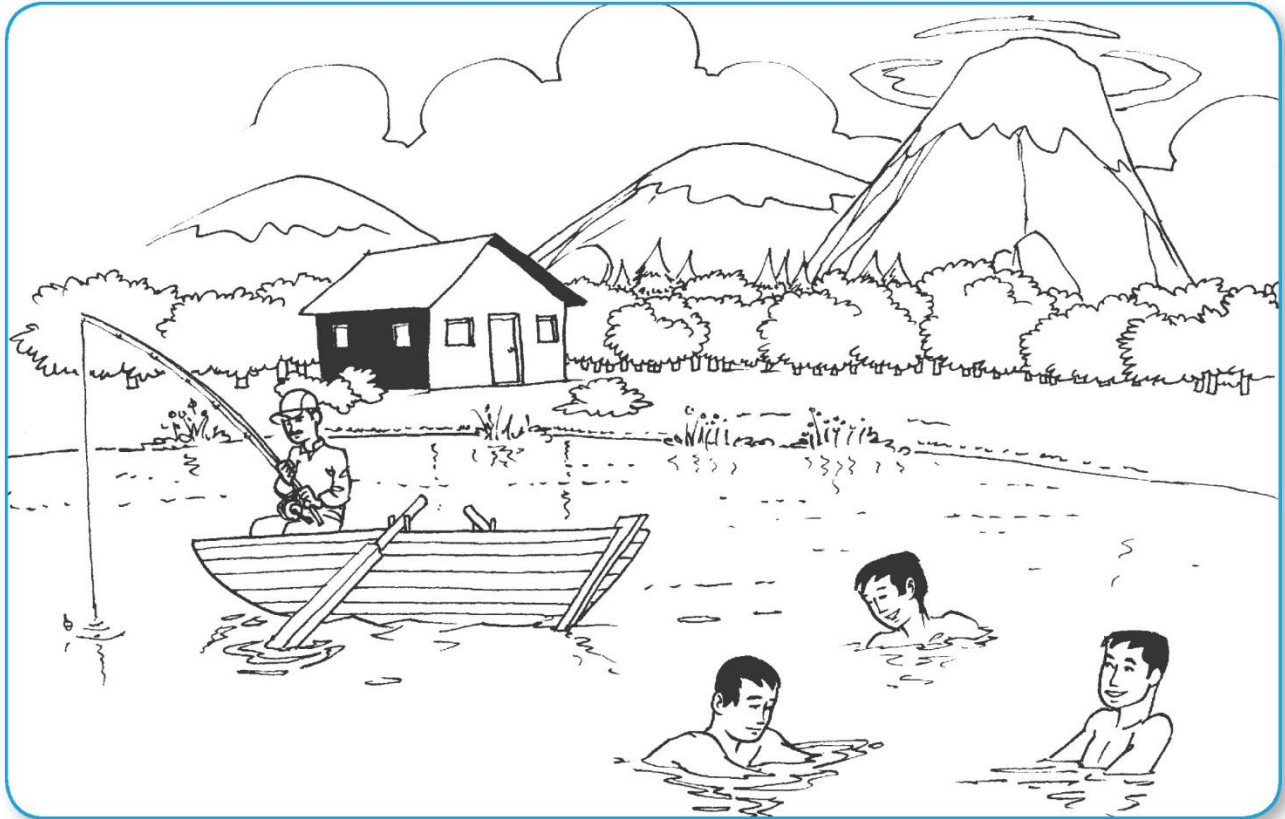

- | | | | | | | | | | | | |
|-----------|--------------------------|---------|--------------------------|--------|--------------------------|----------------|--------------------------|-------------|--------------------------|---------|--------------------------|
| beautiful | <input type="checkbox"/> | beach | <input type="checkbox"/> | shells | <input type="checkbox"/> | island | <input type="checkbox"/> | mountain | <input type="checkbox"/> | rainy | <input type="checkbox"/> |
| snow | <input type="checkbox"/> | river | <input type="checkbox"/> | lake | <input type="checkbox"/> | sea | <input type="checkbox"/> | fishing | <input type="checkbox"/> | walking | <input type="checkbox"/> |
| swimming | <input type="checkbox"/> | running | <input type="checkbox"/> | forest | <input type="checkbox"/> | large building | <input type="checkbox"/> | small house | <input type="checkbox"/> | | <input type="checkbox"/> |

10. Write a description of the picture.

Unit 12

On Holiday

1. The date today is Wednesday 16th June. Write the dates.



1. What date is it the day after tomorrow? _____
2. What date is it tomorrow? _____
3. What date was it the day before yesterday? _____
4. What date will it be in a fortnight? _____
5. What date was it yesterday? _____

2. Think of the words. Do not use the same word twice.

1. Name two water sports. _____
2. Name two sports you play with a ball. _____
3. Name a sport you play with a racket. _____
4. Name two sports you do outside. _____

3.  Saif is on holiday. What is he going to do? Listen and tick (✓).

	golf	scuba diving	tennis	volleyball
Sunday				
Monday				
Tuesday				
Wednesday				
Thursday				

4. Look at the picture and tick (✓).

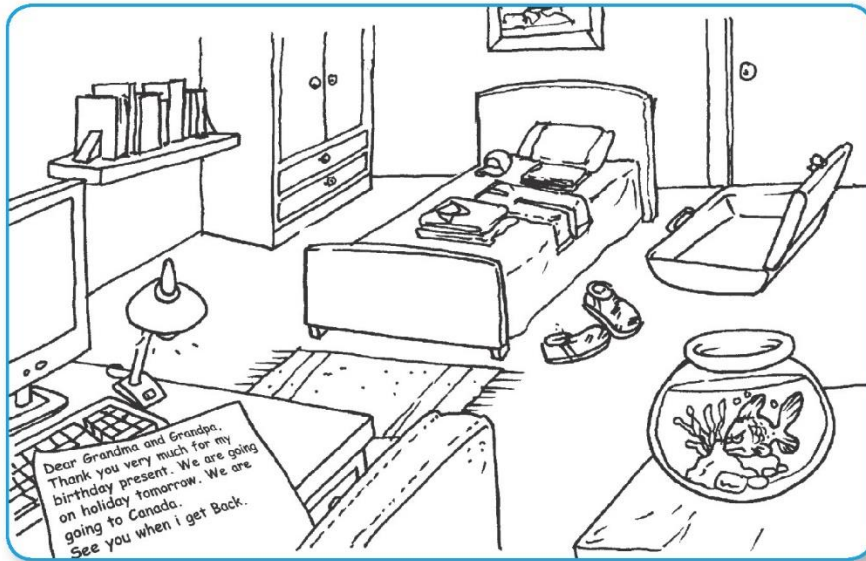

Bader is going on holiday tomorrow. His mother wrote down the things he must do. Has he done them?

Remember

Yet / already are used with the present perfect tense. Yet is used to talk about something that did not happen till this moment. Already is used to indicate that something has happened earlier.

	<i>not yet</i>	<i>already</i>
<i>clean your shoes</i>	✓	
<i>put your clothes in your bag</i>		
<i>put your books on the shelf</i>		
<i>write to Grandma and Grandpa</i>		
<i>give food to your fish</i>		
<i>turn your computer off</i>		

5. Now write sentences.

Bader hasn't cleaned his shoes yet.

1. _____
2. _____
3. _____
4. _____
5. _____

6. Match the holiday photos and the people.

a

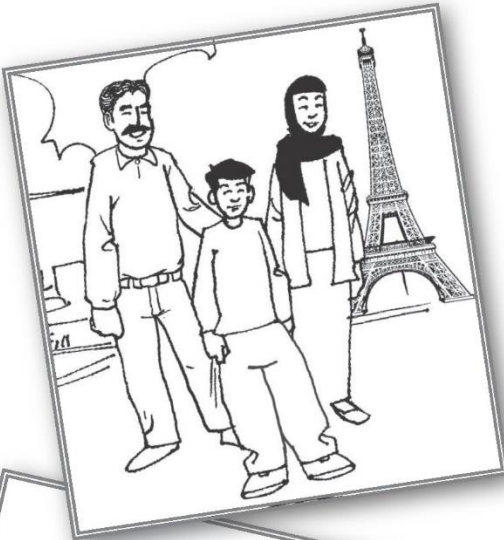

b

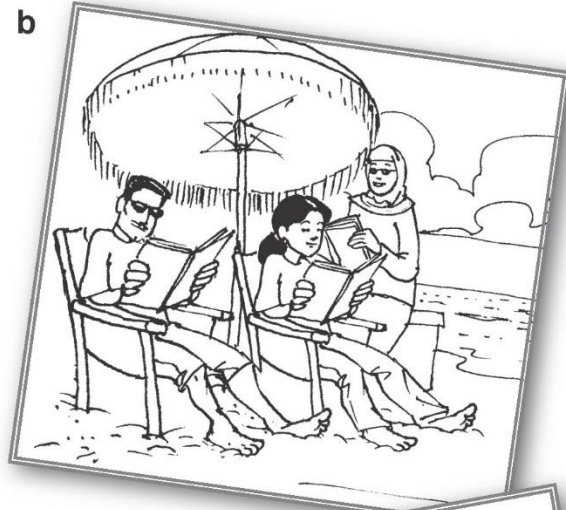

c

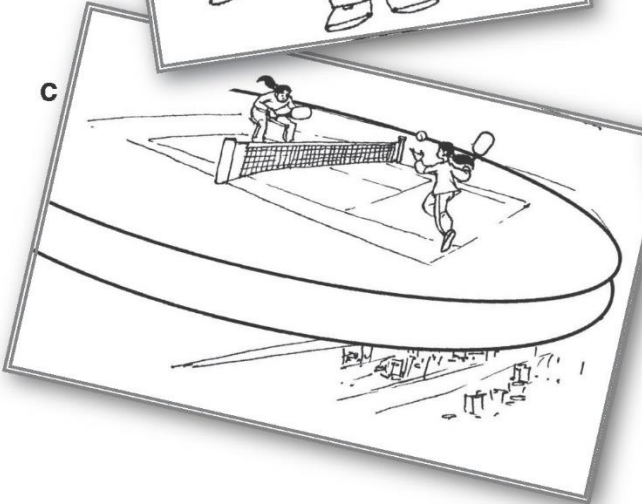

d

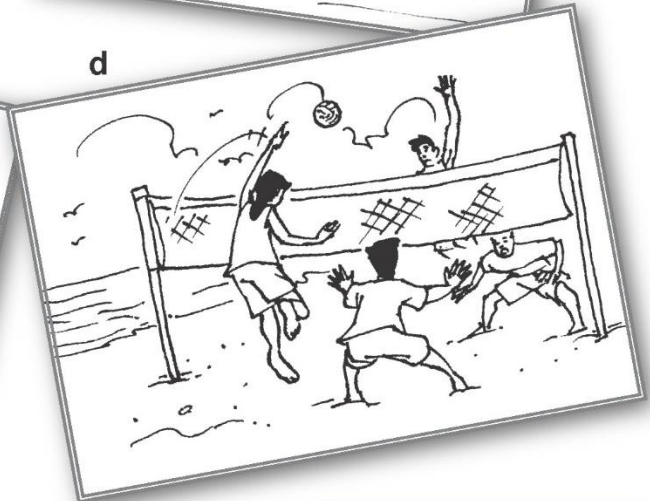

We had a great holiday. We went to the beach everyday. We played volleyball and went to the sea.



We had a wonderful holiday. We walked up a tall tower. The view was great.



We had the best holiday. The weather was beautiful. We went to the beach but we didn't play we sat and read our books.



We had a great holiday. We stayed in a wonderful hotel and played tennis on the roof! The view was beautiful!

7. Tell the members of your group what you did on your last holiday.

8. Join the beginnings and the endings. Make correct sentences.

- | | |
|---|------------------------------------|
| 1. <input type="checkbox"/> we arrived | a) by plane |
| 2. <input type="checkbox"/> We came | b) some wonderful museums |
| 3. <input type="checkbox"/> We're staying | c) in some interesting restaurants |
| 4. <input type="checkbox"/> I've visited | d) on Saturday |
| 5. <input type="checkbox"/> I've eaten | e) at a very old-fashioned hotel. |

9. Complete the checklist below. Share your choices with your group.**Things I want to do on holiday**

- | | |
|---|--|
| <input type="checkbox"/> Take photographs | <input type="checkbox"/> play tennis |
| <input type="checkbox"/> Scuba diving | <input type="checkbox"/> read stories |
| <input type="checkbox"/> Eat ice-cream | <input type="checkbox"/> Do yoga |
| <input type="checkbox"/> Go fishing | <input type="checkbox"/> Ride a horse |
| <input type="checkbox"/> Visit interesting places | <input type="checkbox"/> Go camping |
| <input type="checkbox"/> Go shopping | <input type="checkbox"/> Visit museums |

10. You are on holiday. Write an e-card to your best friend. Use these questions as a guide:

- Where are you?
 What is the weather like?
 What is the food like?
 Where are you staying?
 What interesting places are there to visit?

11. Design and type the e-card using your smart devices and send it to your friend.

Writing an E-Card

12. Think of a place for a holiday. Find information about it. Write it here.

Where do you want to go?
What's the weather like?
How can you get there?
What can you see there?
What can you do there?

13. You are on holiday. Finish this e-card.

Dear _____,

I am having a wonderful holiday here in _____.

The weather is _____.

Yesterday we went _____.

It was _____.

Tomorrow we are _____

See you soon.

Progress Check

Reading

Canada is the second largest country in the world. It is in the northern part of North America. It is near the USA and Greenland. It is also next to the Pacific, Arctic, and Atlantic Ocean. It has the longest coastline in the world. Toronto is the biggest city but Ottawa is the capital.

A large number of people from almost every part of the world come to live in Canada. Around 35 million people now live in it. English and French are widely spoken in Canada. The Canadian people are friendly, polite and helpful. They are also famous for respecting laws and rules.

Canada welcomes millions of tourists every year. There are plenty of attractions to see like the Niagara Waterfalls, Lake Louise, and the CN Tower. Tourists can do a lot of activities, too. In the summer, they can go swimming, camping and cycling. During the winter, they can enjoy skiing, skating and playing hockey.

1. Complete the following graphic organizer with information from the text.

Location		People
Attraction to see		Activities to do

2. Answer the following questions.

1. What does the underlined word “plenty of” in the 3rd paragraph mean?

2. What does the underlined pronoun “they” in the 3rd paragraph refer to?

3. Would you advise your friends to visit Canada? Why? Why not?

3. Complete the e-mail below with words from the box.

lake / family / tennis / math / mountains / scuba diving / swimming / forest

Dear Ahmed,

How are you? I'm fine. My all say "Hi"

Last weekend we visited my aunt and uncle. They live near some

There is also a in front of their house. My cousins and I went

..... in it. It was great fun. Behind their house is a

I don't think any dangerous animals live there!

Tomorrow I'm going to play after school and at the

weekend I'm going to go This evening I have to do my

..... homework.

Write soon, Ahmed

Best wishes,

Peter

Grammar

4. Complete these sentences with "yet" or already".

1. Have you visited a different country
2. I have read an English book this month. Have you?
3. I haven't tried to play golf Have you?
4. I have stayed in three different hotels. Have you?

5. Put the adjectives in the following sentences in the correct form.

1. The Nile is the (long) river in the world.
2. Which is (big), Qatar or Saudi Arabia?
3. The blue whale is the (heavy) animal in the world.
4. Eating fruit and vegetables is (healthy) than eating fast food.

