

Look at each picture, choose the correct answer

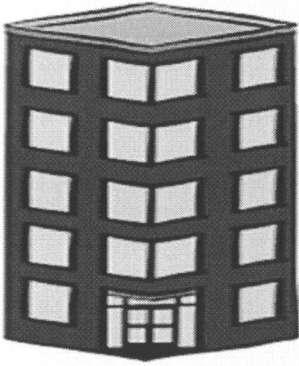

I live in a flat in Sharjah

I live in a big villa.

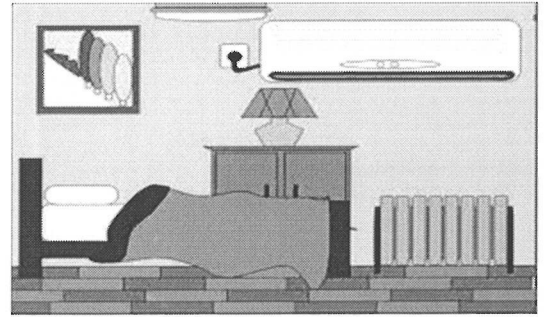

We watch tv in the living room.

I want to sleep in my room.



She is in the garden

He is in the garden

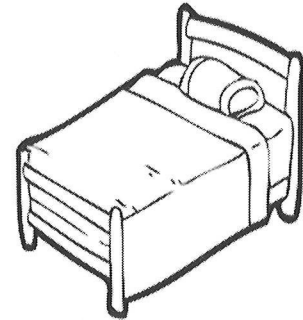
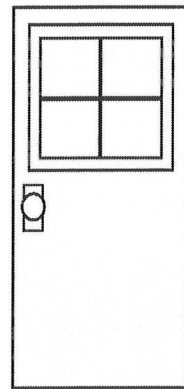

The bed is next to the door.

The beds are next to the door.

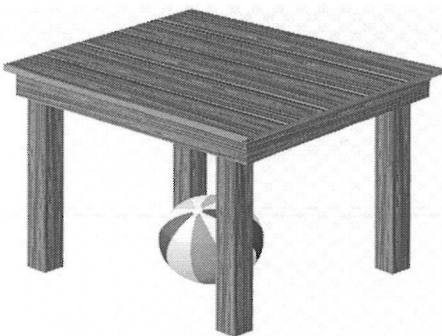

The ball is under the table.

The balls are under the table



The boy is on the roof.

The girl is on the roof

Look at each picture, choose the correct answer

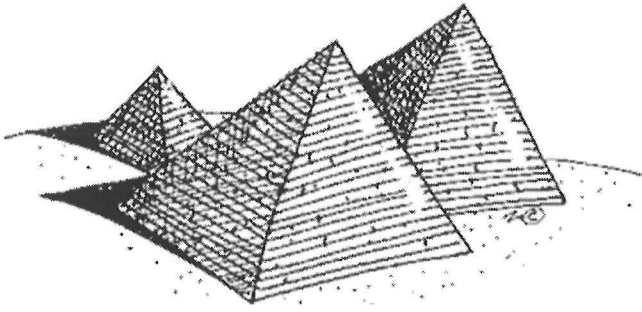

We can see pyramids in Egypt
I can go to the mall on Friday.

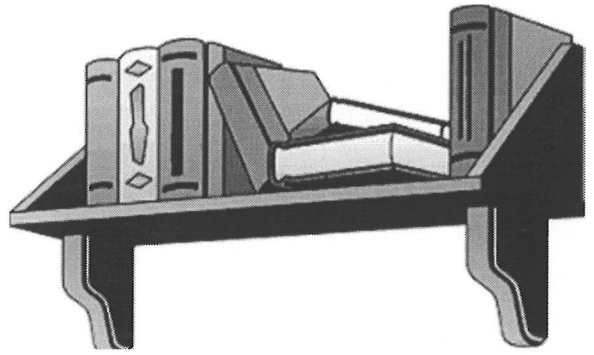

The books are on the shelf.
The books is on the shelf.

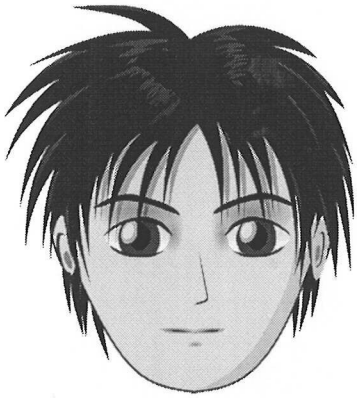

She has straight black hair
He has a straight black hair



She has long curly hair.
She has brown curly hair.



husband , wife and two daughters
husband , wife , and two sons



husband , wife, one son and daughter .
husband , wife and one son

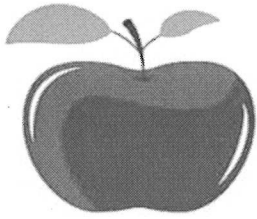

shutterstock.com • 708636439

It's a drink.

It's a fruit.

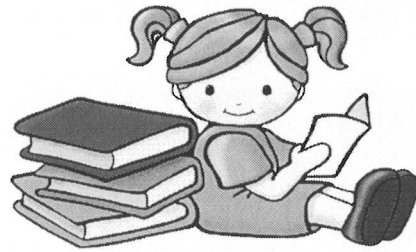

It's not a sport

It's a sport.



He has a ball and a robot.

He have a ball and a robot.



He speak English

He speaks English .

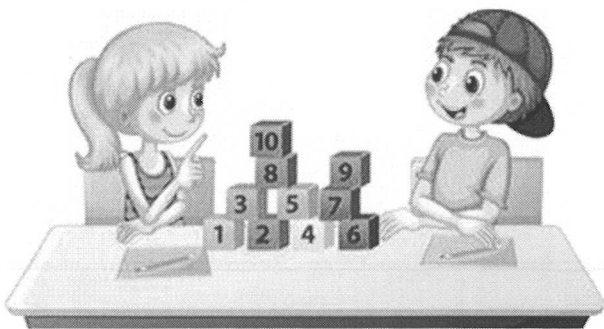

They are clever in math

They are good at swimming.

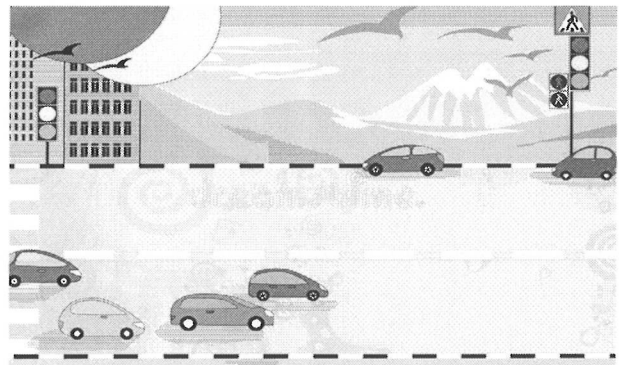

I don't see cars in the city

I see cars in the city .

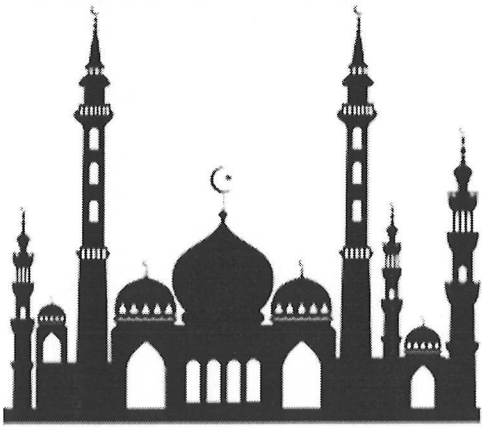

I'm going to pray now,
Let's go to the park

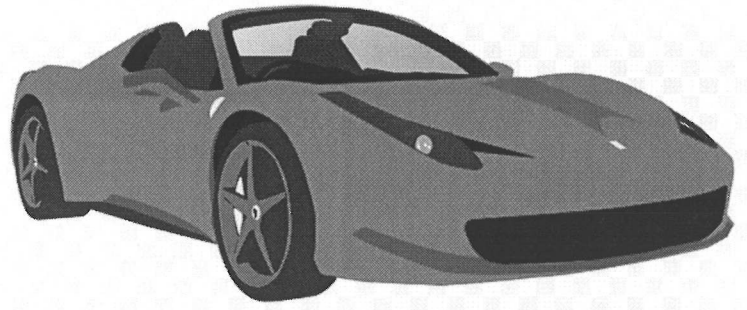

It's expensive ,
It's a plant..

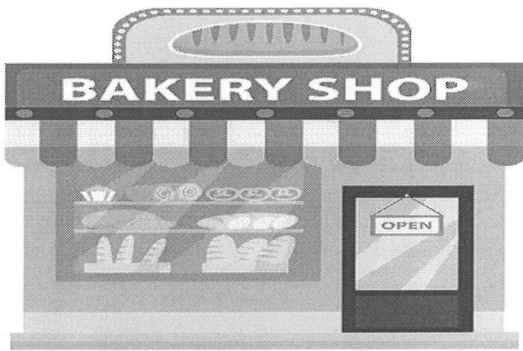

Let's buy ice creams
Can you give some breads?

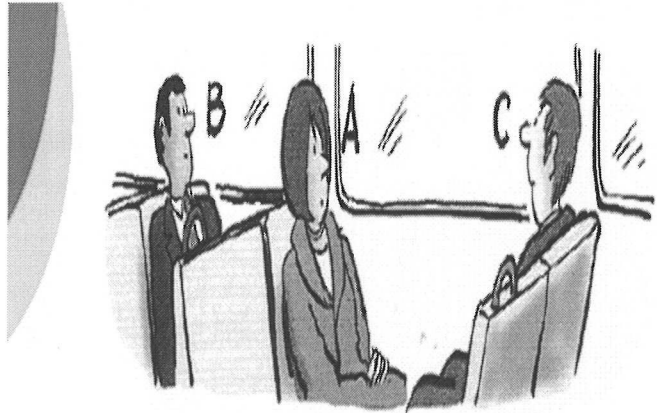

A is sitting opposite C
A is sitting behind C

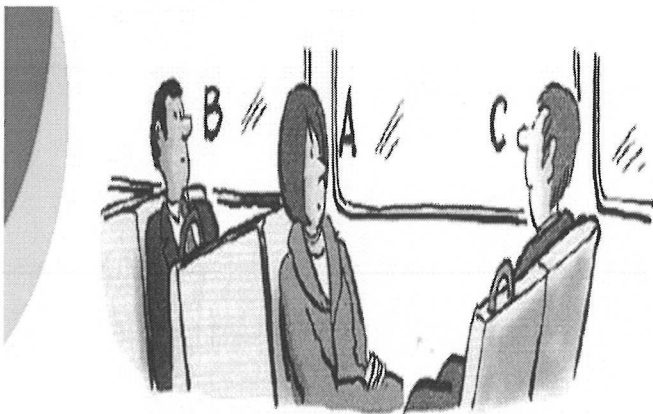

C is sitting between A and B
C is sitting in front of A



He can't write
He can read and write .

Complete the sentences, circle the correct word.

1-I want to take the..... to go to the mall

Metro school

2-We have to pray in the

Mosque sky.

3-I'mI'm good at math

bad clever

4-I.....curly black hair

has have

5-The boycurly black hair.

has have

6-What does a robot do?.....

It clean. it cleans

7-She.....speak Arabic

don't doesn't

8-My brothers.....sports

play eat

9-coffee is a

fruit drink

معلمة تأسيس
تدريس جميع المواد
عجمان والشارقة
خبره طويلة داخل الدولة
أسعار مناسبة
من الصفوف 1 الي 5
منهح الوزارة فقط
للتواصل
0555909112

Complete the sentences, circle the correct word.

1-We like to in the kitchen

sleep

cook

2-Mayed and Salem live in

Dubai

tree

3- Today we are going to swim in the swimming.....

school

pool

4-This house is made of

tomato

wood

5-are the pencils? In the box

Where

What

6-My sister has straighthair

blonde.

Stories

7-It's 10:20.....

Ten- forty

ten -twenty

8-We have In the morning

breakfast

dinner

9- I will have my dinner in the

Evening

morning .

Read , then Match short titles with their texts.

I live in Hong Kong. It is a big city. It is noisy. There are fast cars and tall buildings. There are lots of shops and malls.

I live in Ras Al-Khaimah . I Live in a village in the mountain. It is quiet and it is clean.

I live in Fujairah , I live near the sea. My town is old and quiet. There are nice beaches. There aren't many big shops.

A-It's an old city

b-a busy city.

C-Living in mountain areas

Read , then Match short titles with their texts.

Muscat is a beautiful city. It is the capital city of Oman. It is next to the UAE. Many people visit this city because it has many old places . It has old markets , people can buy old items,

We can visit the Sultan Qaboos Grand Mosque. It is big and white. It is a beautiful mosque. You can go to the beach. There is a nice beach called Qurum beach. There are lots of trees and the sea is clean.

There are many hotels some are big and expensive. There are cheap hotels too. You can stay at your hotel and read a book.

معلمة تأسيس
تدريس جميع المواد
عجمان والشارقة
خبيره طويلة داخل الدولة
أسعار مناسبة
من الصفوف 1 الى 5
منهج الوزارة فقط
للتواصل
0555909112

A-staying at hotels
B-Buying old things
C-visiting places

Read , then Match short titles with their texts.

Hello , my name is Tom . My favorite food is Kushari , from Egypt.

I always eat it.

My favorite drinks tea and coffee. I love them. I always have
coffee in my breakfast.

My best friend is my brother. I feel happy when I play
football with him in the club.

My favorite animal are desert animals I like the oryx. I wish
to take many photos of this animal.

A-His favorite animal.

B- His best friend

C-His favorite food

D-His favorite drink



Read each passage. Match the question numbers (1-5) to the letters (A-C). You can use each letter more than once.

A-Ali:

I live in one floor house. The kitchen, living room, dining room and office are at the front of the house, and all the bedrooms and the bathroom are at the back. I love it because I don't have to walk up and down the stairs all the time!

B-Sara:

I live very high up, in a high-rise at on the 25th floor. I live with my family and cat. It's very modern and comfortable. I like where I live because we have incredible views of Abu Dhabi and the sea.

C-Sultan:

I live in a nice house with my family. It has two floors. My room is near the stairs. Our neighborhood is peaceful and quiet to live in. There are many shops and beautiful playgrounds. I love it because there's a park at the back and lots of my friends live in the same street. We ride bikes and play together.

1. **Who says that his room is in the first floor?** _____

 2. **Who describes a home that has more than 2 floors?** _____

 3. **Who describes a bungalow house?** _____

 4. **Who describes a home in which does Not have stairs?** _____

 5. **Who says that the ocean view is amazing from his house?** _____
-

Read each passage. Match the question numbers (1-5) to the letters (A-C). You can use each letter more than once.

A-Tala:

I live in Bangkok, in Thailand. There are a lot of cars in my city and the roads are very busy. That's why I go to school by small Vehicle. It's faster than walking and you don't get stuck in traffic jams! The driver can drive between cars, so we don't have to wait behind them. The only problem is that this vehicle is open on each side, so you breathe in the traffic fumes!

B-Zack:

In Manila, in the Philippines, where I live, we get to school by big vehicle. It has two benches in the back, so a lot of kids can travel at once. It's really good fun travelling with all my friends like this. But the ride is often very bumpy because the benches are quite high up, and sometimes it's a bit of a squash!

C-Mai Lan:

My dad takes me to school on his rickshaw. I live in Ho Chi Minh City, in Vietnam, and everybody here travels by rickshaw! I like it because I get to spend time on my own with my dad. But during the monsoon it can rain really hard and then it is not so much fun travelling by rickshaw. Even with our waterproof clothing, we still get wet!

1. Who goes to school with a lot of friends? _____
 2. Who uses jeepeny to get to school? _____
 3. Who describes a tuk tuk? _____
 4. Who describes a vehicle that is Not open from top or sides ? _____
 5. Who says that his town has busy roads? _____
-

Read and circle the correct answer (A-C).

Animal specialist Dr. Noor Al Amudin told Gulf News: 'Animal homes are lost as people use the land to build houses. They drive over land with four-wheel drives and catch animals to sell for money. All these things have endangered some animals in the UAE.'

The UAE is home to many beautiful animals, such as camels and cormorants. Animals, such as the Hawksbill turtle, Arabian leopard and the Arabian tahr are all examples of endangered animals. The Arabian tahr is endangered because the places it lives have been used for building homes. For a long time, people have caught and killed Arabian Leopards for money. This has left leopard numbers very low. It can be difficult to find an answer, but the country is working to look after and help endangered species. There are rules to stop people building houses on the places where these animals live. With protection, the Arabian leopard may live in peace and have more babies, to let the number of leopards grow again. Putting rubbish in the sea is killing sea animals, such as the Hawksbill turtle, because their home is no longer safe. If you are at the beach, take your rubbish home and help your local wildlife.'

1. Dr. Noor Al Amudin studies A. Animals B. Homes C. People	2. Some animals in the UAE are endangered bercause of A. Animals B. houses C. people
3..... homes are lost as people use the land to build houses. A. The Arabian tahr B. camels C. cormorants	4. Arabian Leopard numbers are very low because they were hunted for..... A. a working B. money C. houses
5. Putting rubbish in the sea is killing A. Arabian Leopard B. Hawksbill turtle C. Sea	

Read and circle the correct answer (A-C).

There are three ways of transport all over the world, land transport, air transport and sea transport. Cars, trucks, trains, trams, undergrounds, bicycles and buses are called land vehicles.

Most people all over the world use the land vehicles to get to their work. In the UAE, for example, most people use cars to get to their work. Buses come in the second place.

Tram is a kind of bus, but it goes on tracks on roads. The underground is a kind of train, but it goes underground. It is used in Egypt and UK. It is called subway in the USA. Ships, boats, steamers, ferries and hovercrafts are called sea transport. This kind of transport is the cheapest one all over the world because it can carry large quantities of goods. Planes and helicopters are called air vehicles. Air transport is the fastest and the most expensive one. It is also the most comfortable.

<p>1. Paragraph 1 is talking about</p> <p>A. Kinds of vehicles B types of transport C. The most popular means of transport.</p>	<p>2. There are ways of transport.</p> <p>A. 8 B. 5 C. 3</p>
<p>3. The most used type of transport is</p> <p>A. land transport B. air transport C. sea transport</p>	<p>4. Subway is used in the USA andis used in Egypt and UK.</p> <p>A. Tram B. metro C. underground</p>
<p>5. Planes and helicopters are</p> <p>A. land transport B. air transport C. sea transport</p>	<p>6. the fastest and the most expensive type of transport is the.....</p> <p>A. land transport B. air transport C. sea transport</p>

Read and circle the correct answers

Day 1 I'm sitting in my tent. We're camping tonight on Sir Bani Yas island. I'm feeling scared because there are dangerous scorpions and spiders out there! We set off from Ras Al Khaimah at 7 this morning and set up camp three hours ago. We've just eaten dinner under the stars and it tasted amazing! Tomorrow we're spending time on the beach, so my mum can do her work.

Day 2 It's night-time and I'm writing this while I'm sitting in my tent. This morning, Dad and I went swimming for the third time in the sea. It has been fantastic every time! We've seen lots of different fish and we've seen two turtles since Tuesday! My mum says some types of turtles are endangered in this area.

She's working on a project for the university where she works to find out why turtles and fish are dying.

1. Which is the best title for this text ?

- a. **University project**
- b. **A trip to Sir Bani Yas**
- c. **Endangered animals**

2. The boy was feeling scared because

- a. **Fish and turtles**
- b. **Camping**
- c. **Scorpions and spiders.**

3. They set off from Ras al Khaimah at

- a. **Six in the morning**
- b. **Seven in the morning**
- c. **Seven in the afternoon**

4. His Mum went to Sir Bani Yas to

- a. **Enjoy**
 - b. **Work**
 - c. **Swim**
-

Read the text and choose a title for each paragraph

The titles

- A. Lunch at school in Brazil**
- B. Lunch at school in UAE**
- C. UAE food and drink**
- D. Brazil food and drink**

Question 1 the title

1. My name is Amna. I'm from the UAE. Every day I have a packed lunch at school and I eat it with my friends. I usually have a sandwich with meat and salad and a drink of orange juice.

Question 2 the title

2. Hi! I'm Paolo! I'm from Brazil. At school, my favorite snack is queijadinhas . It's a muffin made from cheese and coconut. Today we're having a green salad to start, then rice and beans.

Questions 3-4

Please fill in the table with the following words : Amna or Paolo

3. Likes to drink orange juice in school	
4. Likes to eat green salad	

Read the text and choose a title for each paragraph

The titles

- A. UAE weather
- B. Facts about the UAE
- C. UAE food and drink
- D. UAE traditional clothes

Question 1 the title

The United Arab Emirates was formed in 1971 and is made up of 7 emirates. The UAE flag is red, green, white and black. Each colour has a meaning: white represents good behaviour, green is for the trees and plants, black is for battles and red represents bravery, strength and courage.

Question 2 the title

The UAE has hot summers and warm winters. The hottest months are July and August, when the average maximum temperatures reach above 45°C. In the Al Hajar Mountains, temperatures are considerably lower, as a result of increased height. Sometimes they can be covered in snow.

Questions 3-4

Please fill in the table with the following words : white or black

3.This colour is for battles .	
4.This colour represents good behaviour.	

Read and answer the questions :

1- prince sultan bin Salman was the first Arab , Muslim ,royal , and youngest person to fly on space shuttle .At the age of 28, he become part of the crew to fly on the STS-51-G discovery. From 17th June to 24th June 1985, prince sultan bin Salman was in outer space.

2- He was born on 27th june,1956 in Riyadh . His father is the king Salman .He lived his early 10years in Riyadh and studied there ,But then he moved to the united states to finish his education .

3- He completed his first degree at Denver university, he got a master degree in social and political science from Syracuse University .In 2006,he became the first tour guide in Saudi Arabia .

4- prince Sultan is also well known for his work with charities and in 2005 he was given an award by the kingdom of Jordan.

1-Read the text and match

Paragraphs

- 1-paragraph 1
- 2-paragraph 2
- 3-paragraph 3
- 4-paragraph 4

headings

- a-Education and works
- b-why he is well known
- c-biggest achievement
- d- Early life

2- Fill in the blanks

Crew – education - Riyadh - charities

1-At the age of 28,he become part of the.....of sts -51G .

2-He was born in

3- He traveled to the united states to finish his.....

Complete the sentences. Circle the correct answers.

<p>Today, I _____ sick.</p> <p>A. am B. are C. is</p>	<p>I can see an apple _____ a book.</p> <p>A. or B. and C. am</p>
<p>I _____ to school by bus.</p> <p>A. goes B. going C. go</p>	<p>She _____ Math.</p> <p>A. likes B. liking C. like</p>
<p>This is _____ desk.</p> <p>A. I B. you C. my</p>	<p>_____ he like cheese?</p> <p>A. Do B. Does C. Doing</p>
<p>Yesterday, I _____ happy.</p> <p>A. is B. was C. am</p>	<p>I like to _____ football.</p> <p>A. playing B. plays C. paly</p>
<p>_____ have money.</p> <p>A. I B. i C. me</p>	<p>What _____ it like?</p> <p>A. am B. are C. is</p>
<p>It is _____ alligator.</p> <p>A. a B. am C. an</p>	<p>Where _____ the shells? Here _____ the shells.</p> <p>A. am B. are C. is</p>
<p>This is _____ map.</p> <p>A. an B. a C. am</p>	<p>Sara can run. _____ is fast.</p> <p>A. He B. She C. It</p>
