

**GOOD
LUCK!**

Grade 5 access
Revision text Book
Semester 1
2019-2020
مذكرة تدريبات عامة للصف
الخامس مستوى Access
الفصل الأول

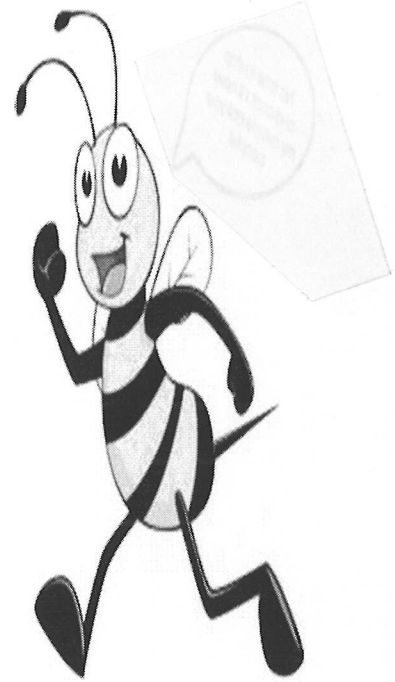

Name: _____

Grade: _____

Class: _____

Look at each picture, choose the correct answer

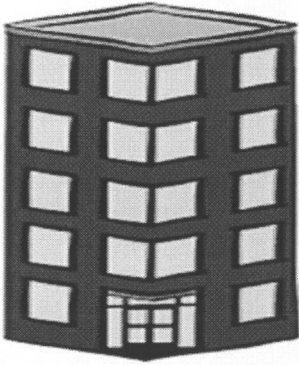

I live in a flat in Sharjah

I live in a big villa.

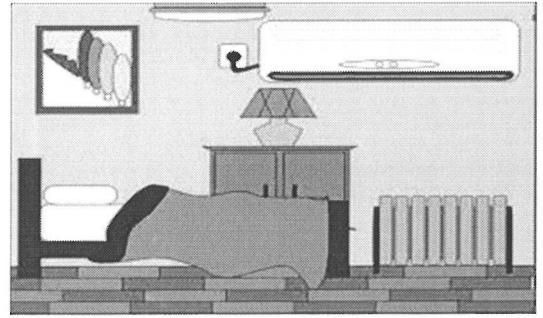

We watch tv in the living room.

I want to sleep in my room.

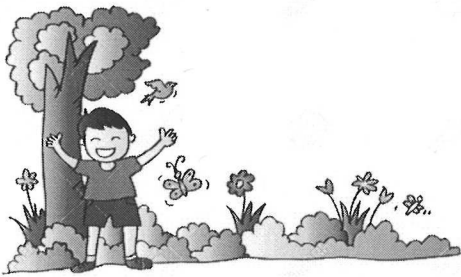

She is in the garden

He is in the garden

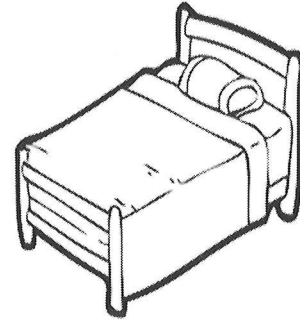
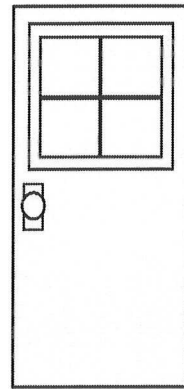

The bed is next to the door.

The beds are next to the door.

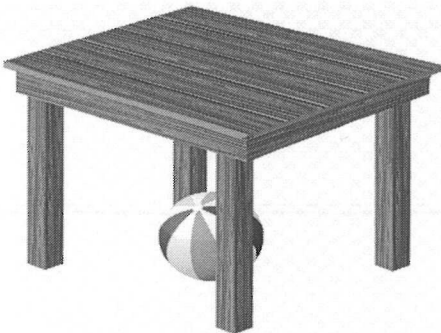

The ball is under the table.

The balls are under the table



The boy is on the roof.

The girl is on the roof

Look at each picture, choose the correct answer

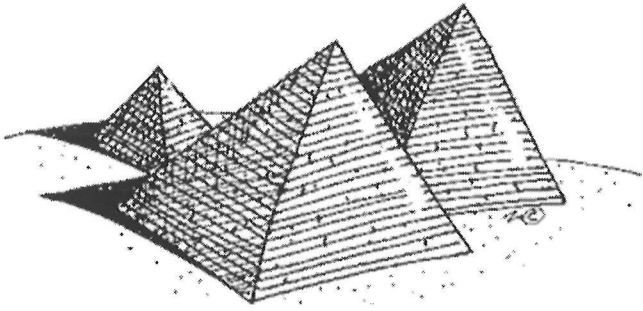

We can see pyramids in Egypt
I can go to the mall on Friday.

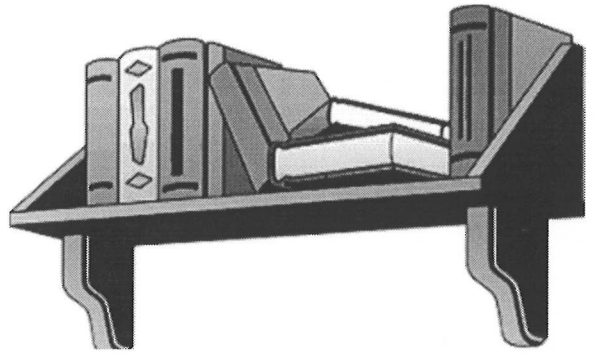

The books are on the shelf.
The books is on the shelf.

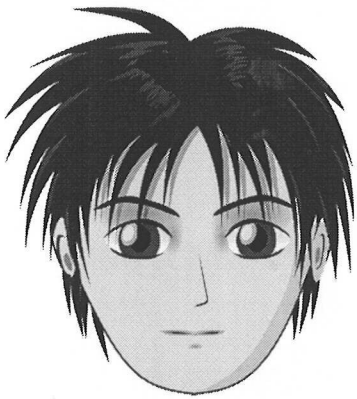

She has straight black hair
He has a straight black hair



She has long curly hair.
She has brown curly hair.



husband , wife and two daughters
husband , wife , and two sons



husband , wife, one son and daughter .
husband , wife and one son

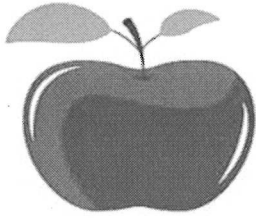

shutterstock.com • 708636439

It's a drink.

It's a fruit.



It's not a sport

It's a sport.



He has a ball and a robot.

He have a ball and a robot.



He speak English

He speaks English .



They are clever in math

They are good at swimming.

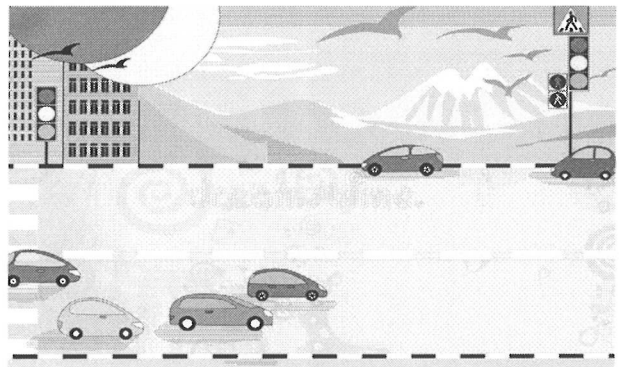

I don't see cars in the city

I see cars in the city .

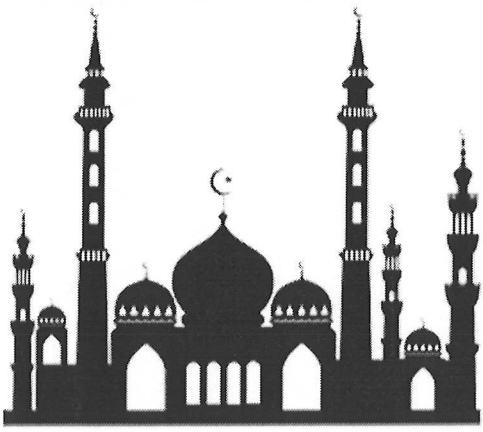

I'm going to pray now,
Let's go to the park

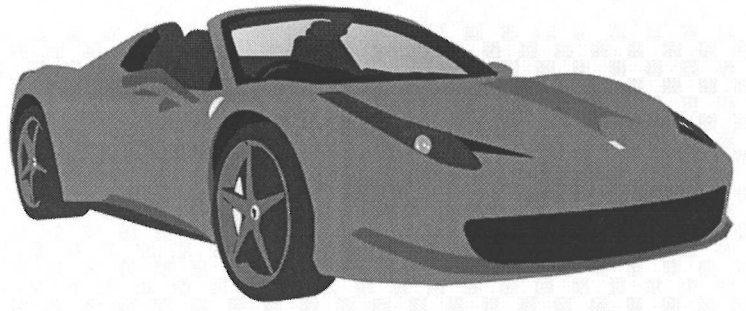

It's expensive ,
It's a plant..

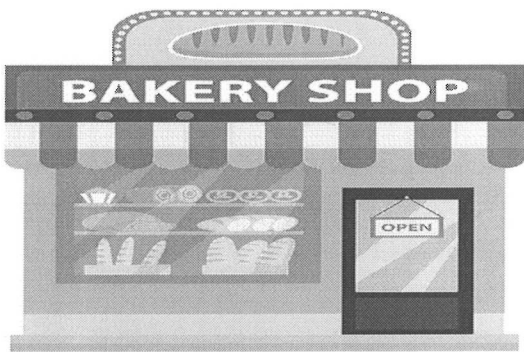

Let's buy ice creams
Can you give some breads?

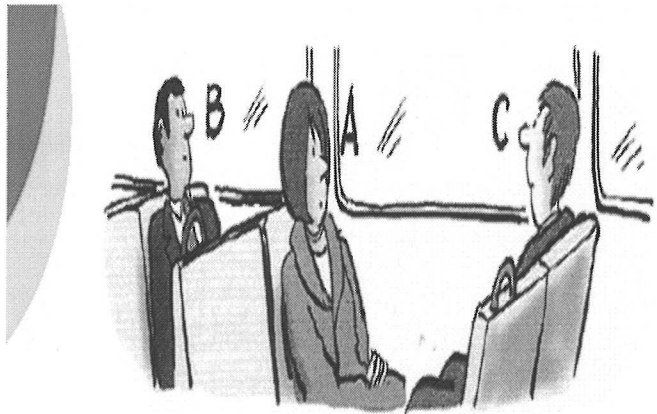

A is sitting opposite C
A is sitting behind C

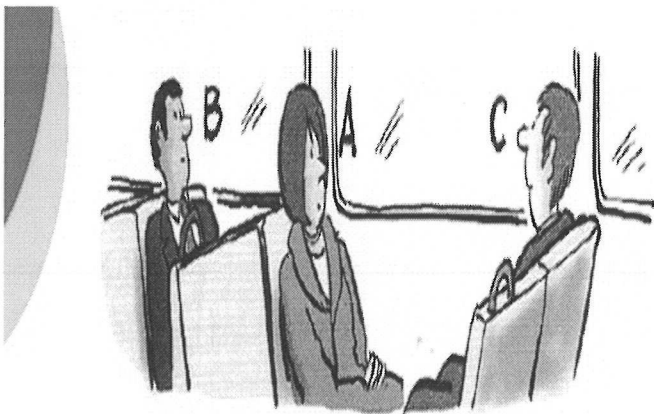

C is sitting between A and B
C is sitting in front of A



He can't write
He can read and write .

Complete the sentences, circle the correct word.

1-I want to take the..... to go to the mall

Metro school

2-We have to pray in the

Mosque sky.

3-I'mI'm good at math

bad clever

4-I.....curly black hair

has have

5-The boycurly black hair.

has have

6-What does a robot do?.....

It clean. it cleans

7-She.....speak Arabic

don't doesn't

8-My brothers.....sports

play eat

9-coffee is a

fruit drink

Complete the sentences, circle the correct word.

1-We like to in the kitchen

sleep

cook

2-Mayed and Salem live in

Dubai

tree

3- Today we are going to swim in the swimming.....

school

pool

4-This house is made of

tomato

wood

5-are the pencils? In the box

Where

What

6-My sister has straighthair

blonde.

Stories

7-It's 10:20.....

Ten- forty

ten -twenty

8-We have In the morning

breakfast

dinner

9- I will have my dinner in the

Evening

morning .

Read , then Match short titles with their texts.

I live in Hong Kong. It is a big city. It is noisy. There are fast cars and tall buildings. There are lots of shops and malls.

I live in Ras Al-Khaimah . I Live in a village in the mountain. It is quiet and it is clean.

I live in Fujairah , I live near the sea. My town is old and quiet. There are nice beaches. There aren't many big shops.

A-It's an old city

b-a busy city.

C-Living in mountain areas

Read , then Match short titles with their texts.

Muscat is a beautiful city. It is the capital city of Oman. It is next to the UAE. Many people visit this city because it has many old places . It has old markets , people can buy old items,

We can visit the Sultan Qaboos Grand Mosque. It is big and white. It is a beautiful mosque. You can go to the beach. There is a nice beach called Qurum beach. There are lots of trees and the sea is clean.

There are many hotels some are big and expensive. There are cheap hotels too. You can stay at your hotel and read a book.

A-staying at hotels

B-Buying old things

C-visiting places

Read , then Match short titles with their texts.

Hello , my name is Tom . My favorite food is Kushari , from Egypt.

I always eat it.

My favorite drinks tea and coffee. I love them. I always have
coffee in my breakfast.

My best friend is my brother. I feel happy when I play
football with him in the club.

My favorite animal are desert animals I like the oryx. I wish
to take many photos of this animal.

A-His favorite animal.

B- His best friend

C-His favorite food

D-His favorite drink